

Proces





BNEXT



BNEXT





BNEXT

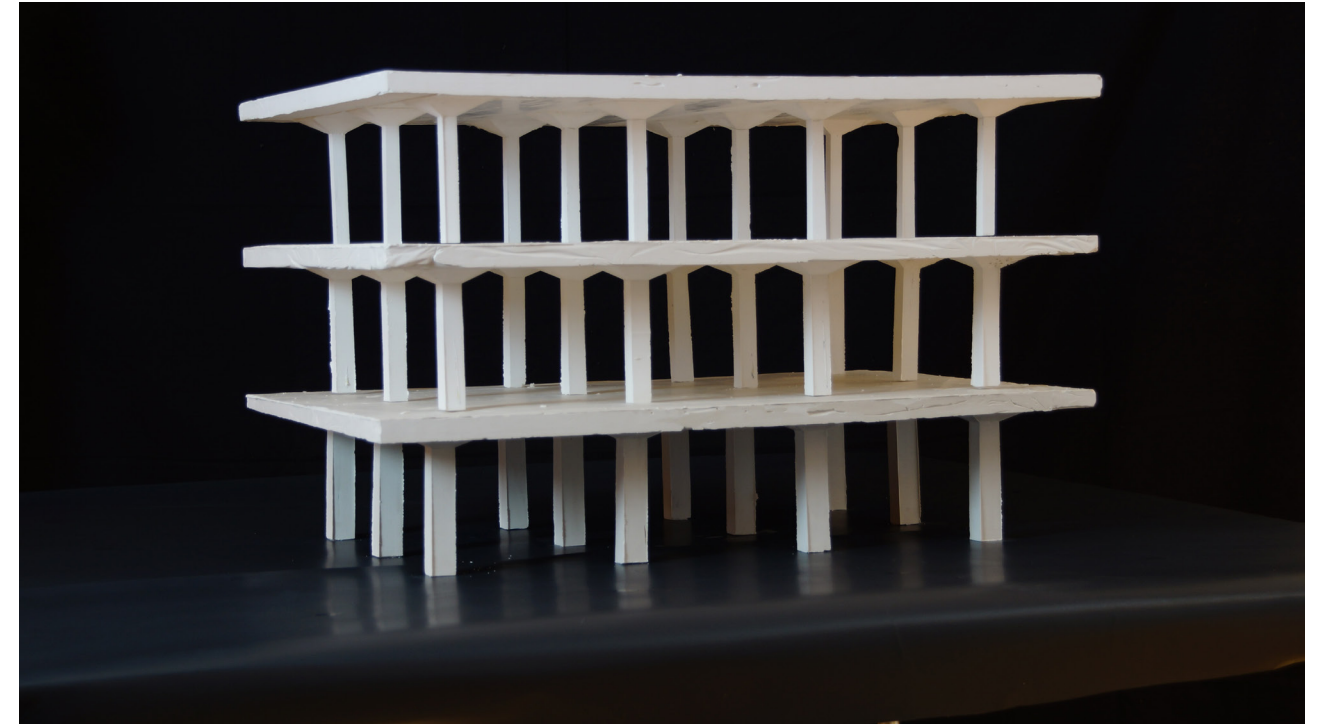

Het eindbeeld



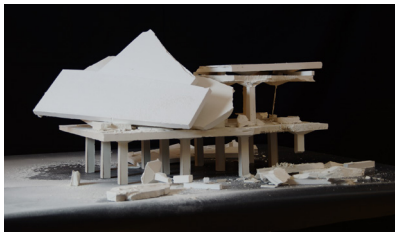
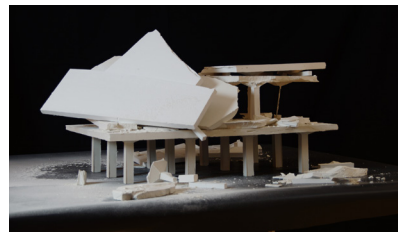
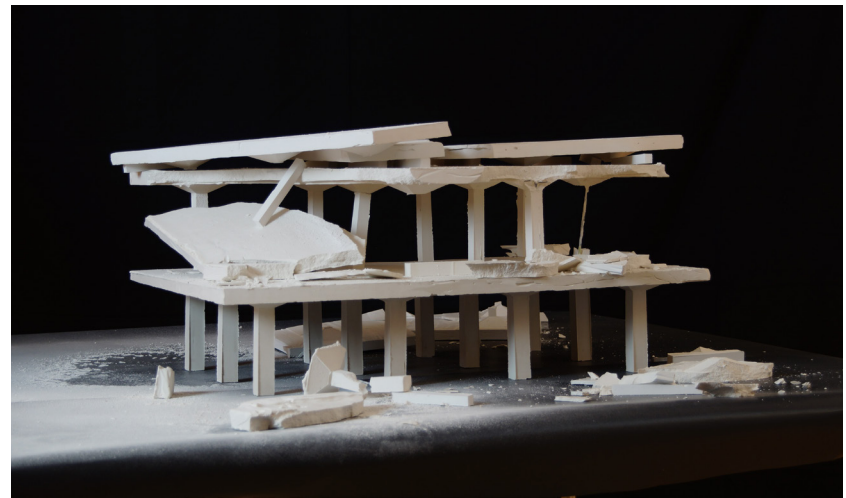

Het proces



Het startpunt



Locatie



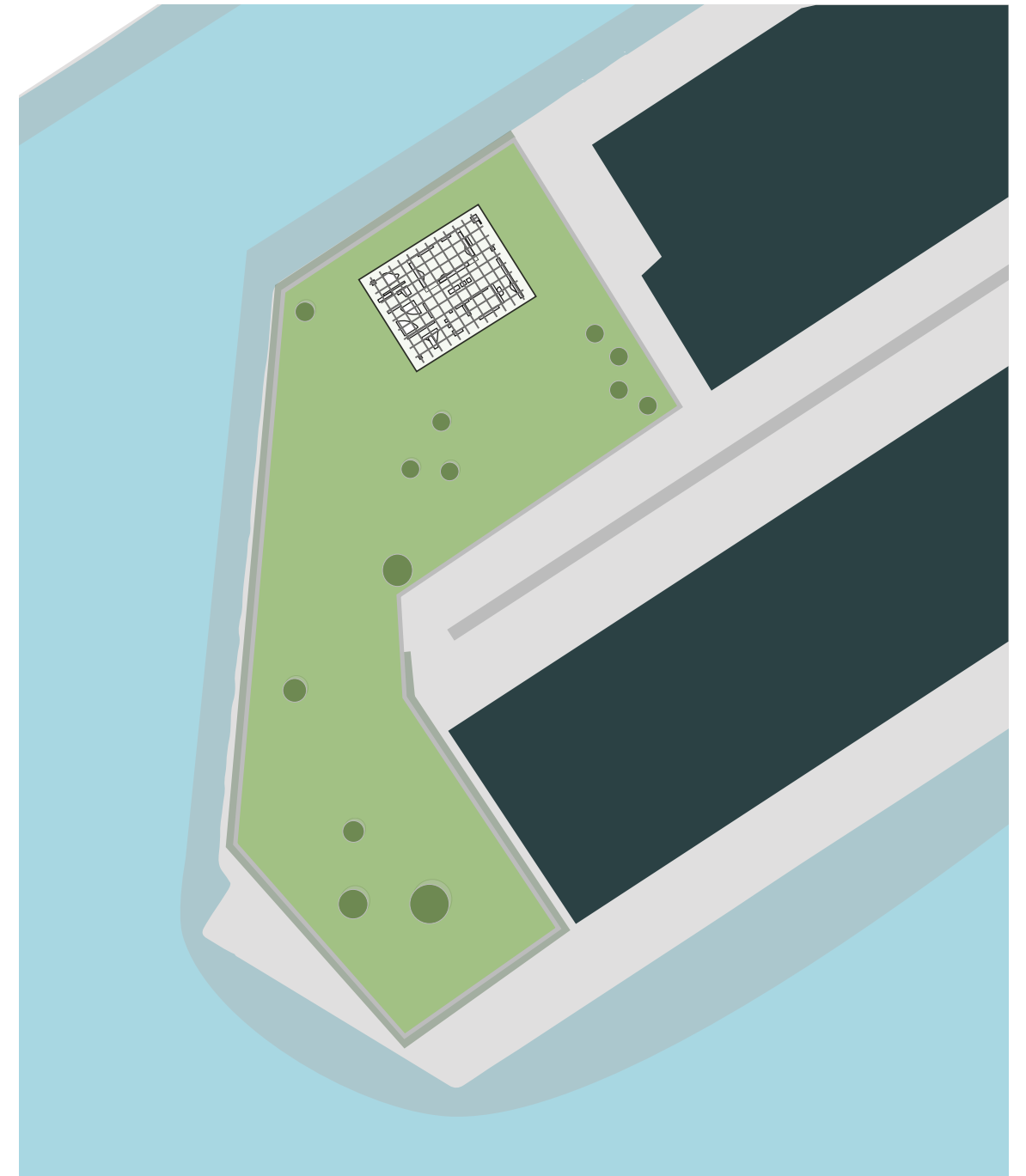

Locatie





Locatie



Locatie





Locatie



Ontwerp



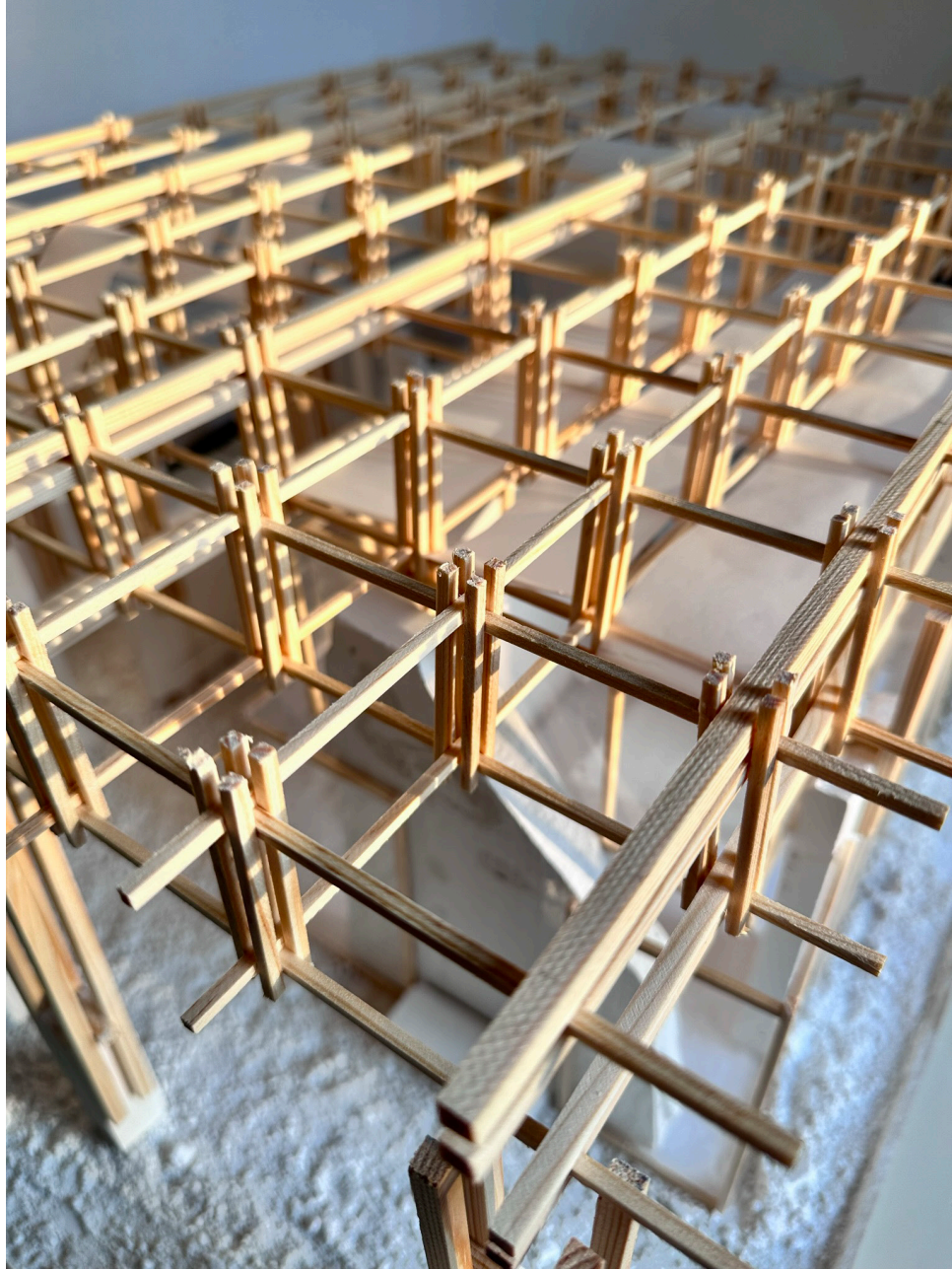

MODEL





MODEL



MODEL





MODEL



MODEL



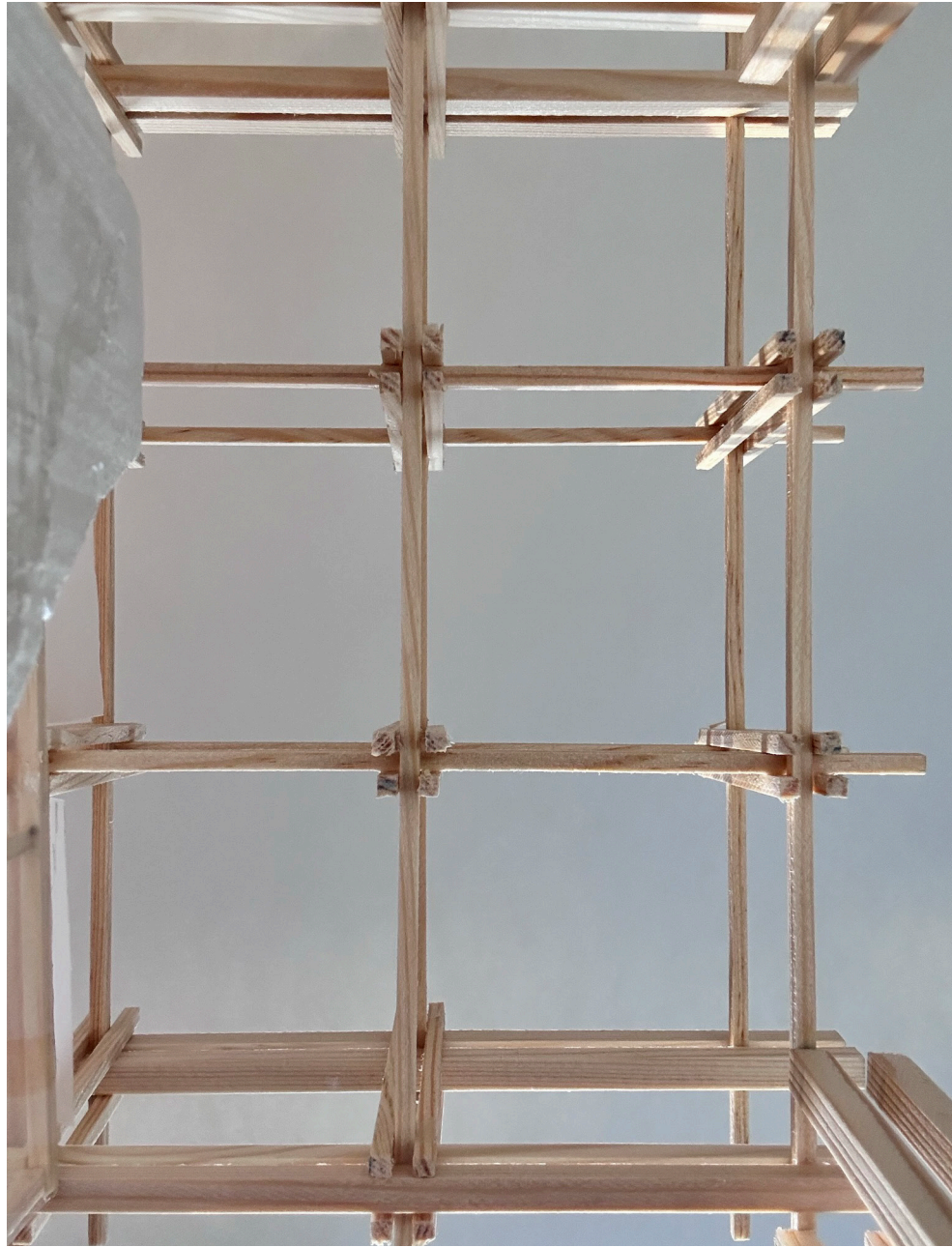

MODEL

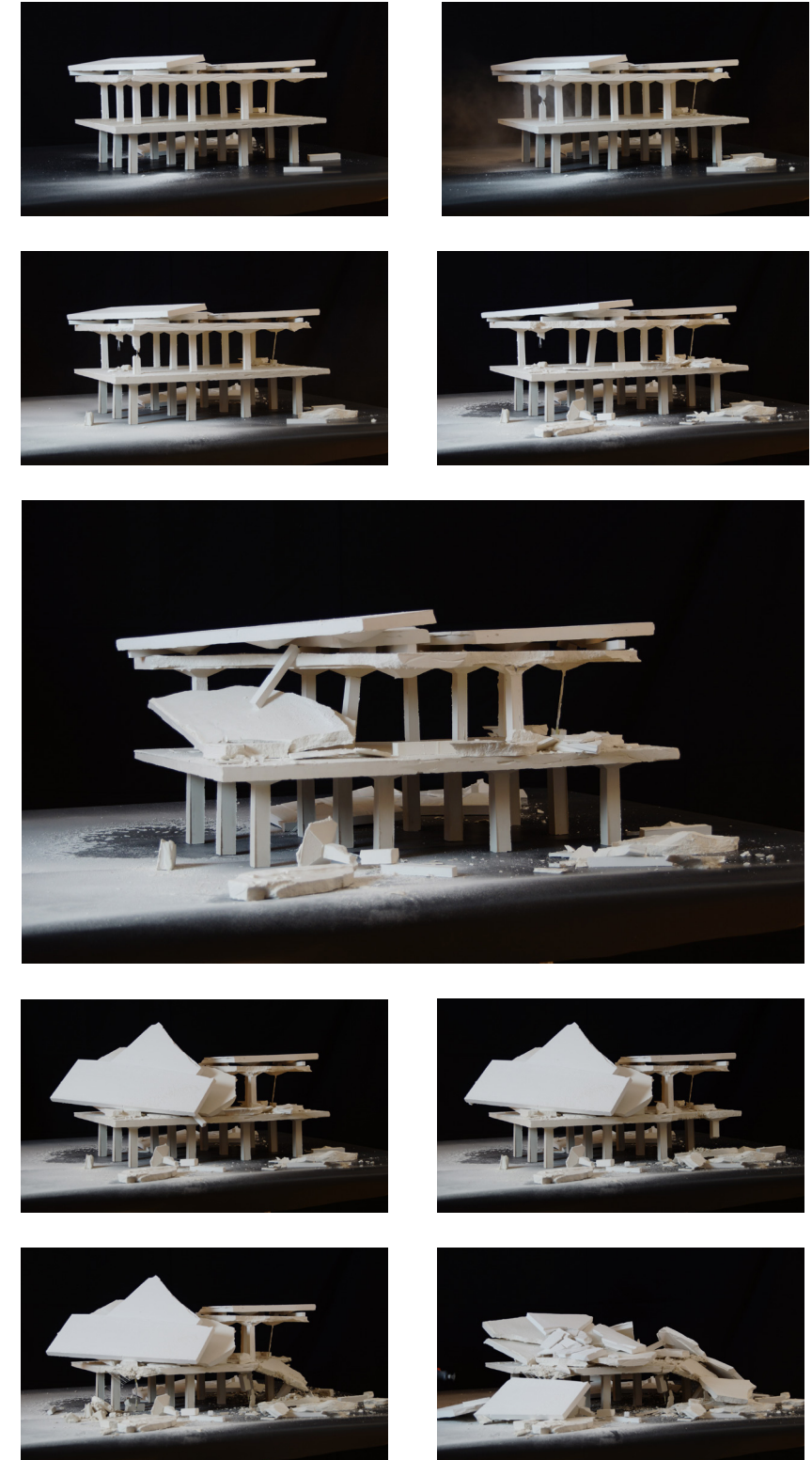

Het proces



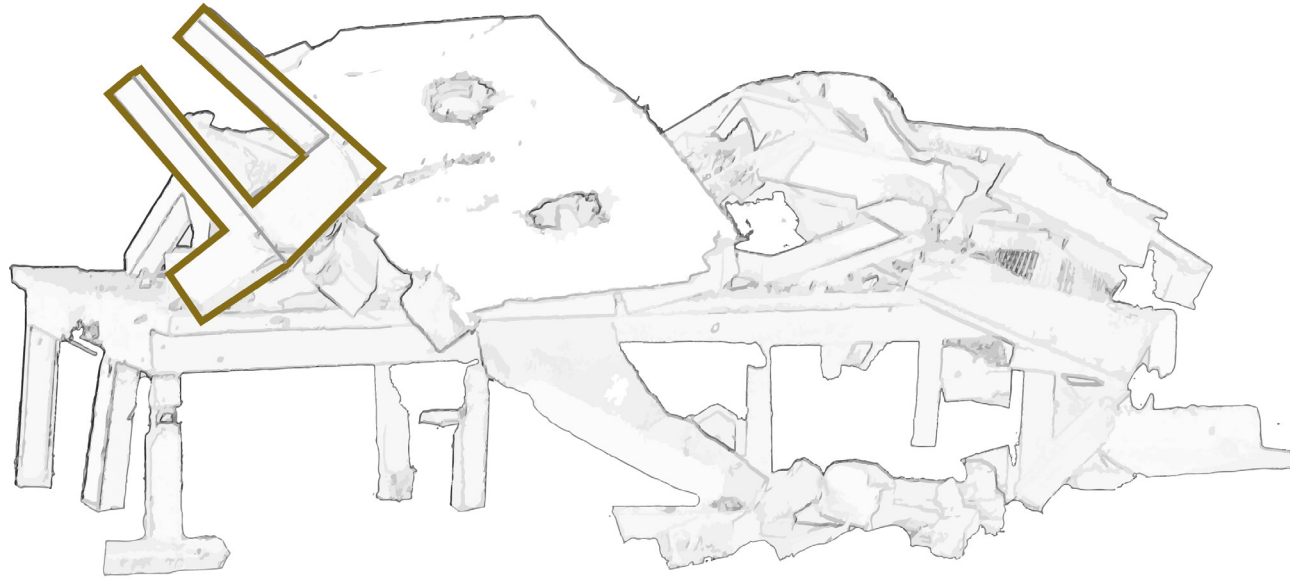

Kenmerkende constuctieve onderdelen

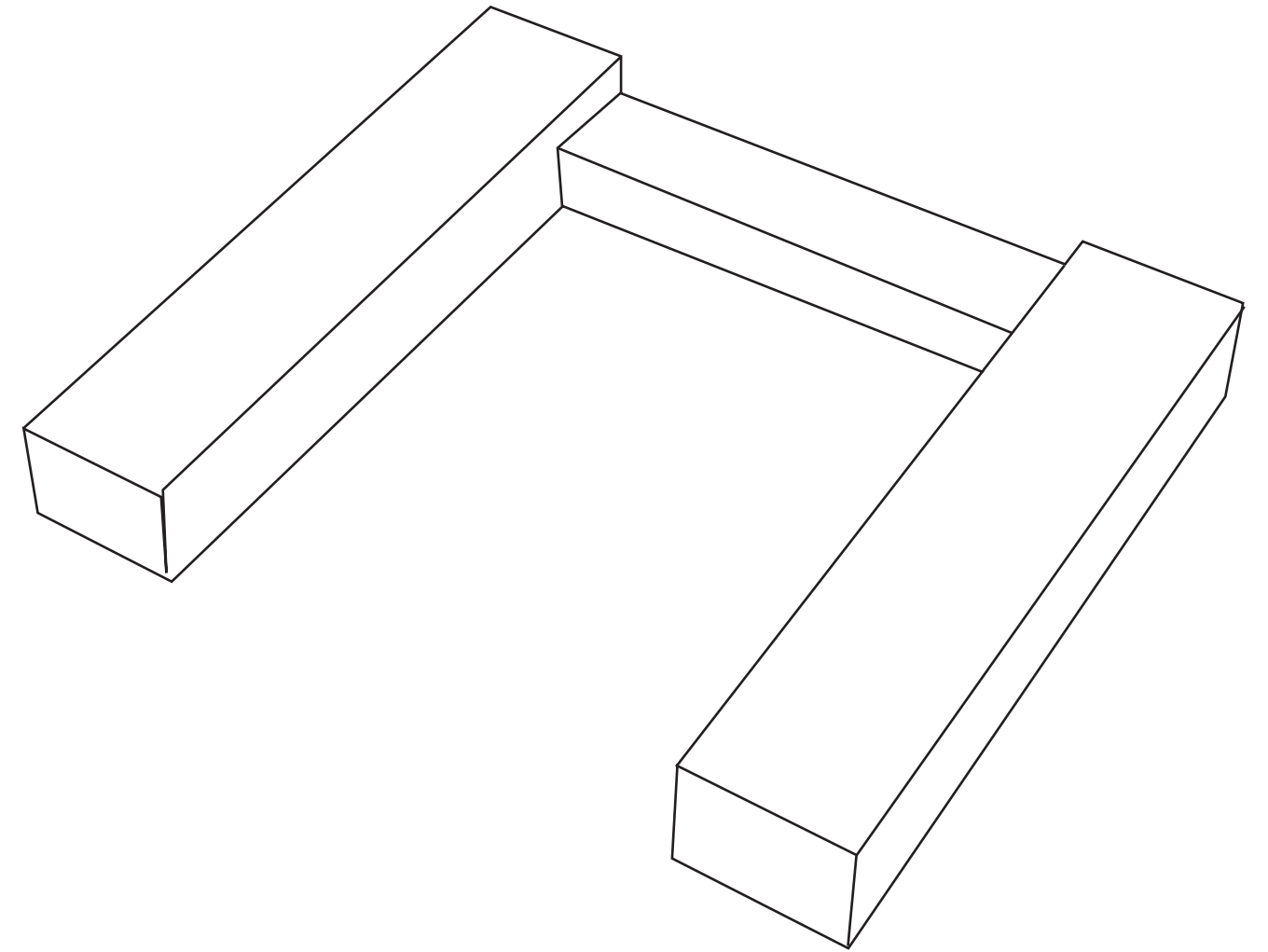

Analyseren



# Tekeningen



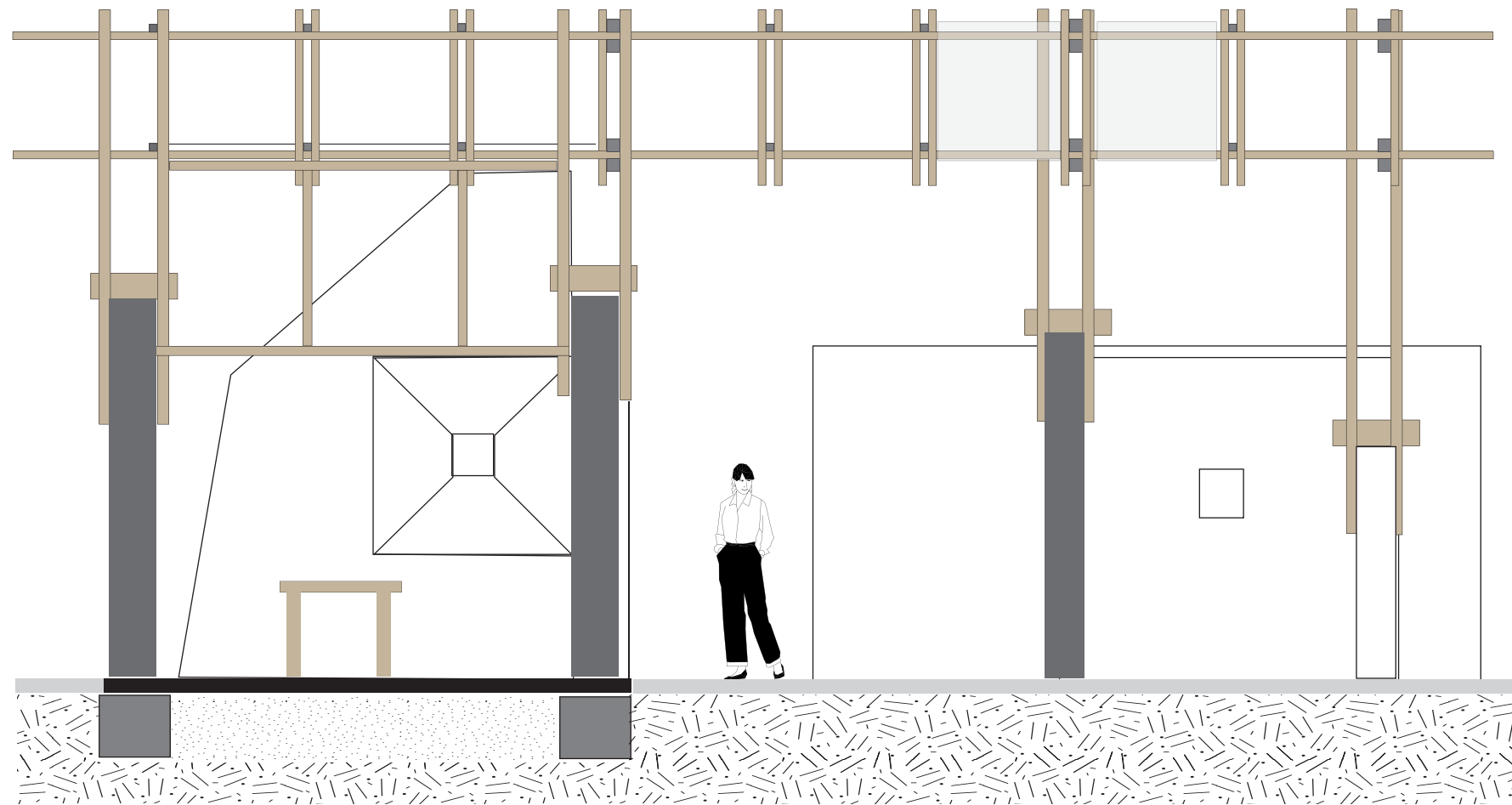

Section

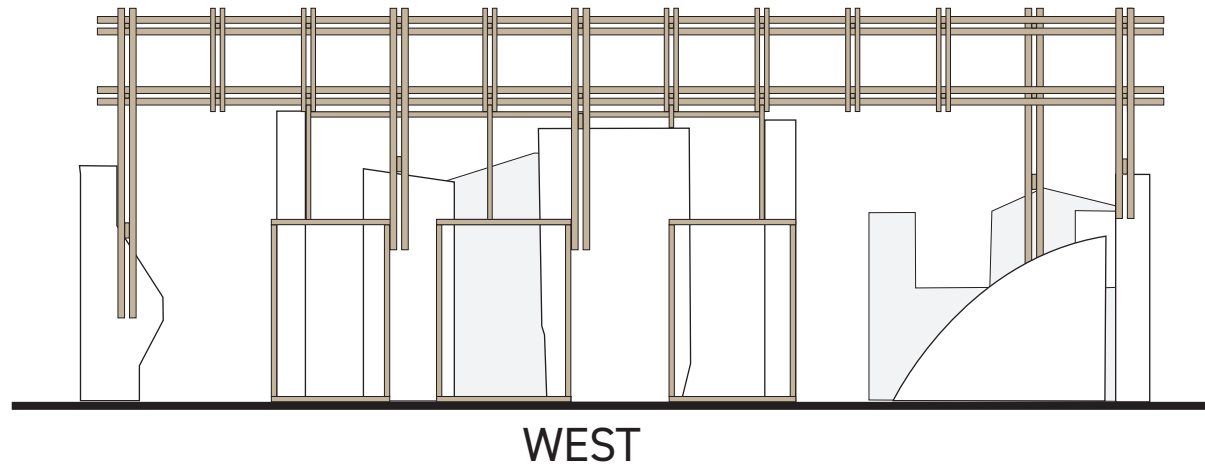

WEST

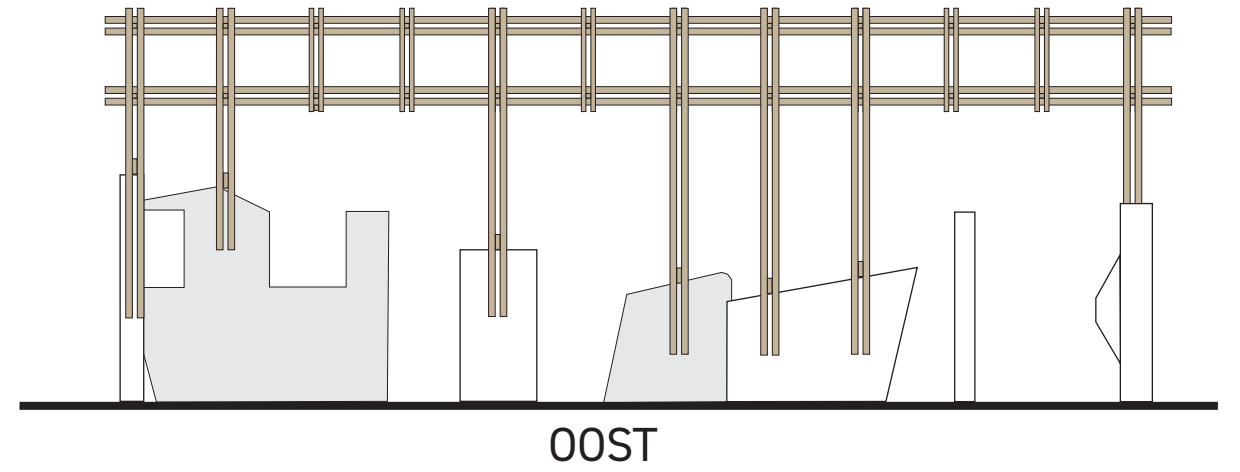

OOST

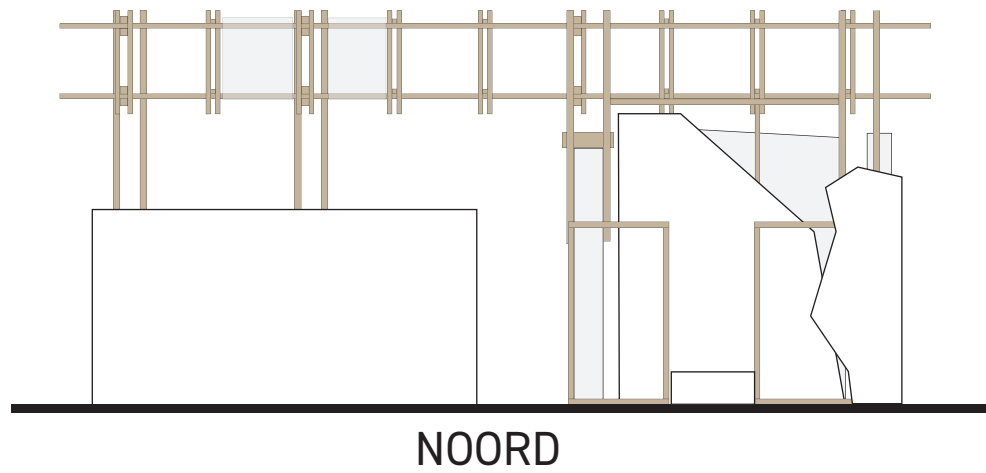

NOORD

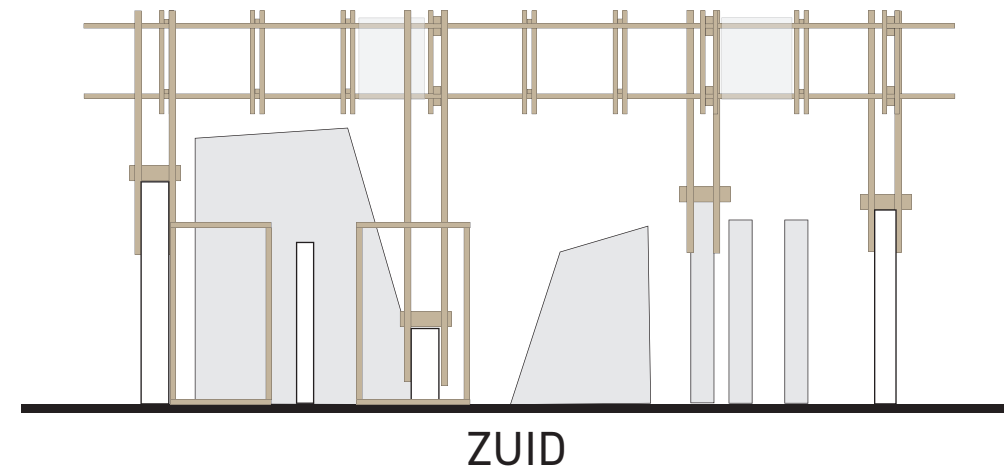

ZUID

Elevations



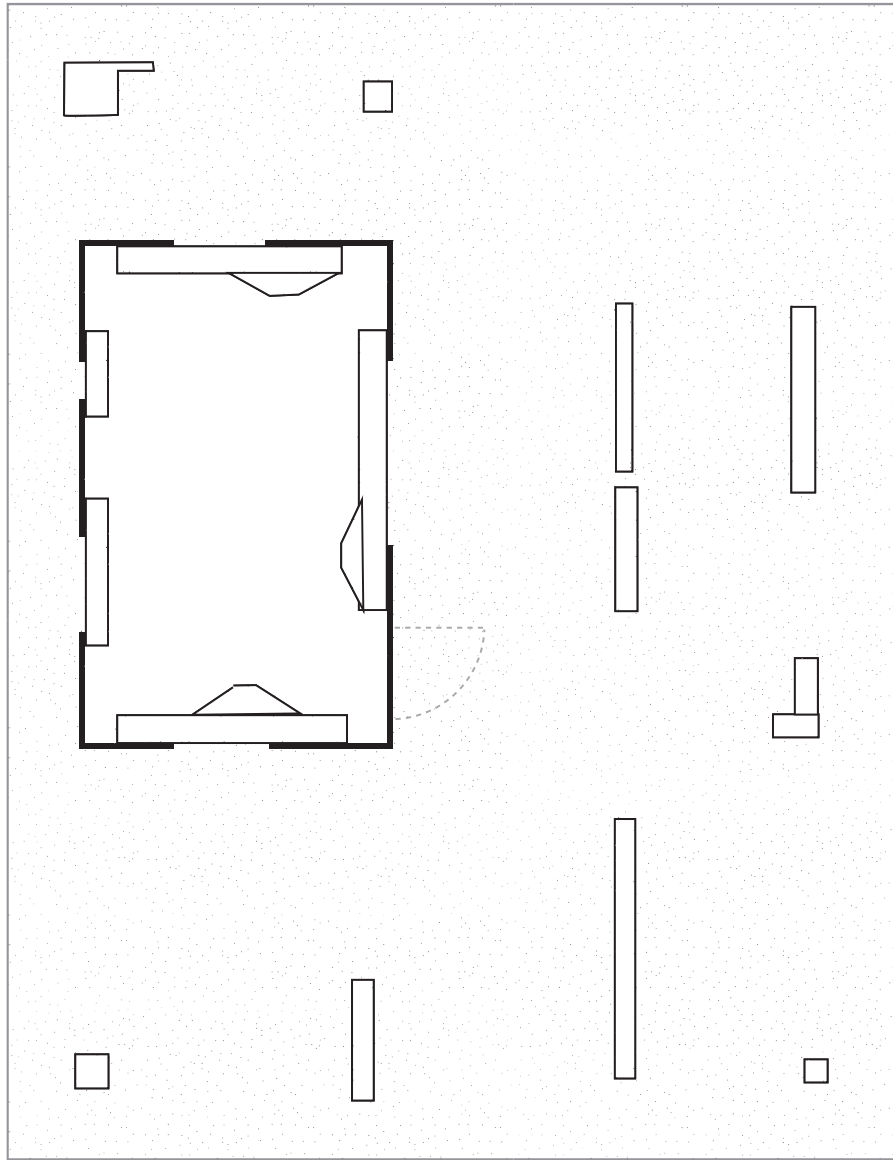

1

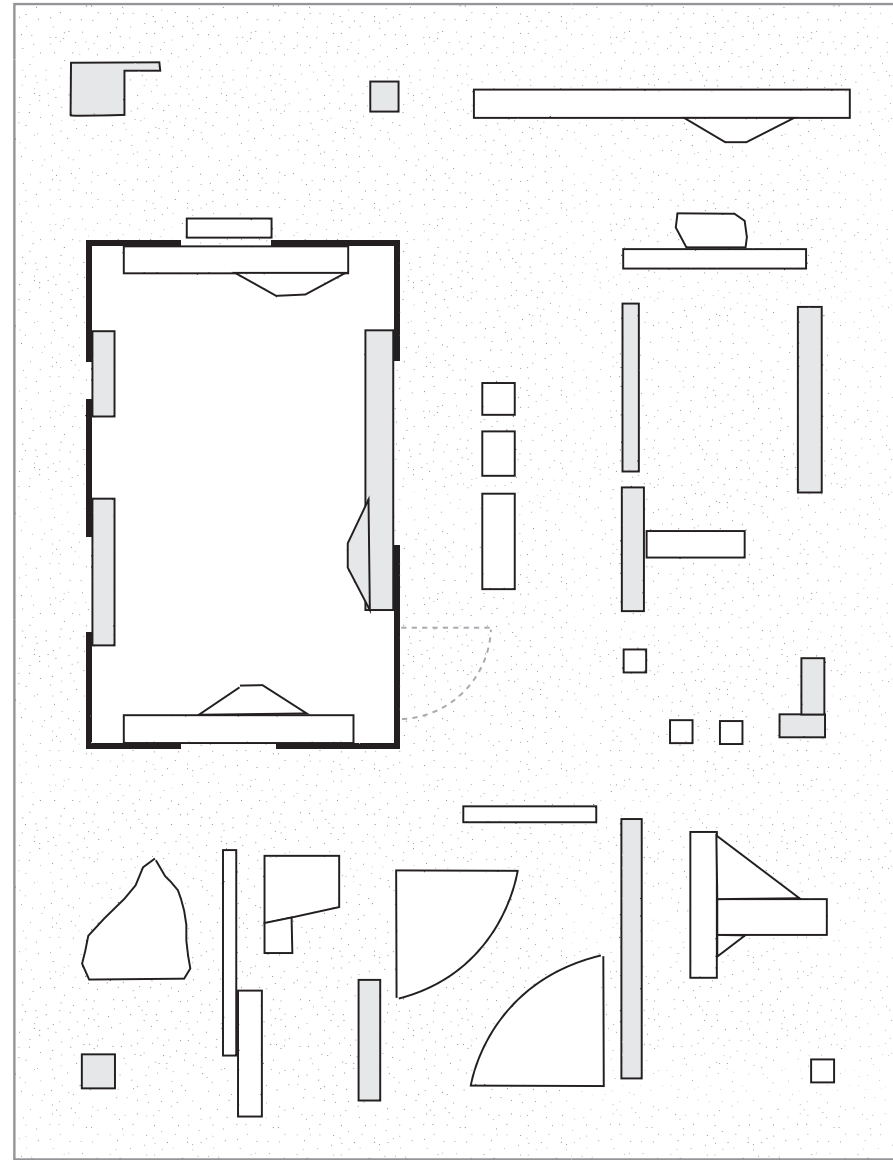

2

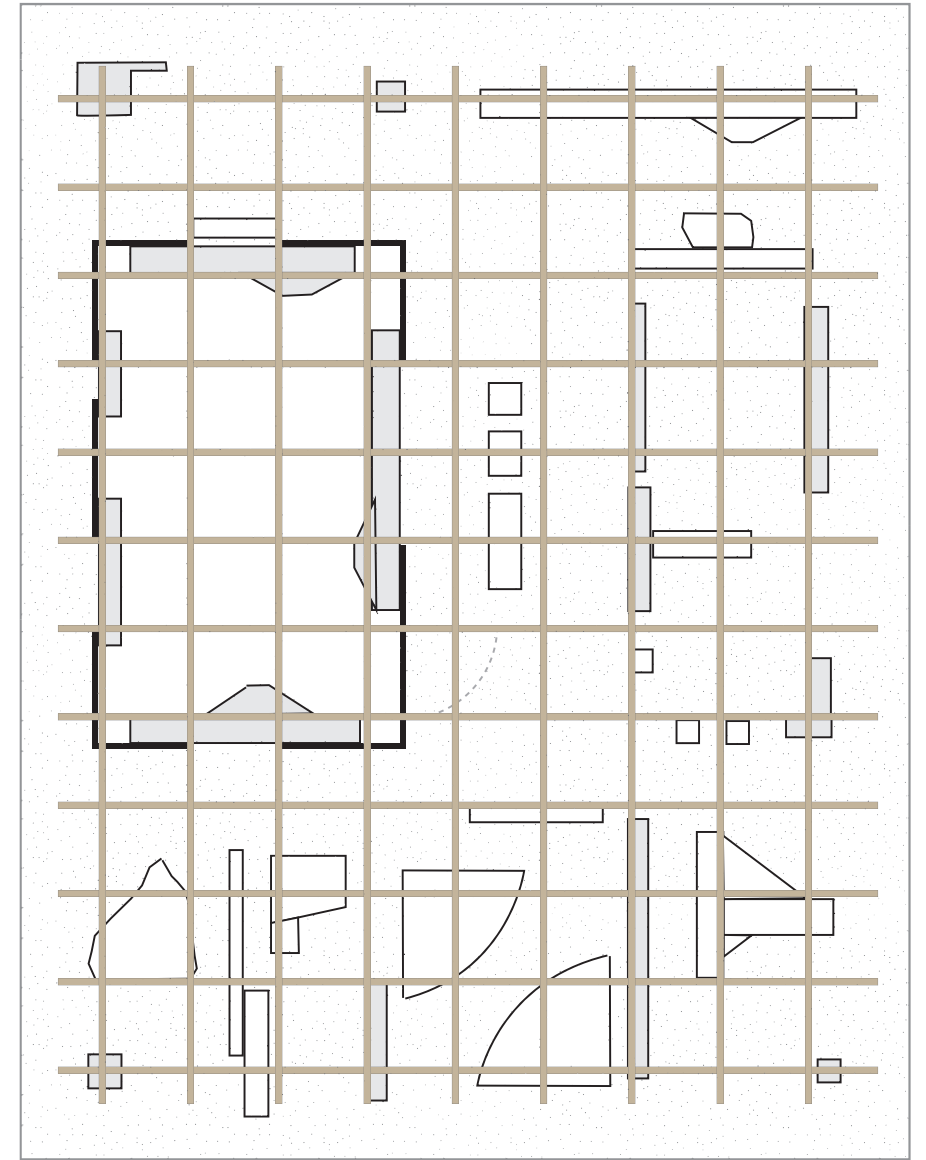

3

Plans

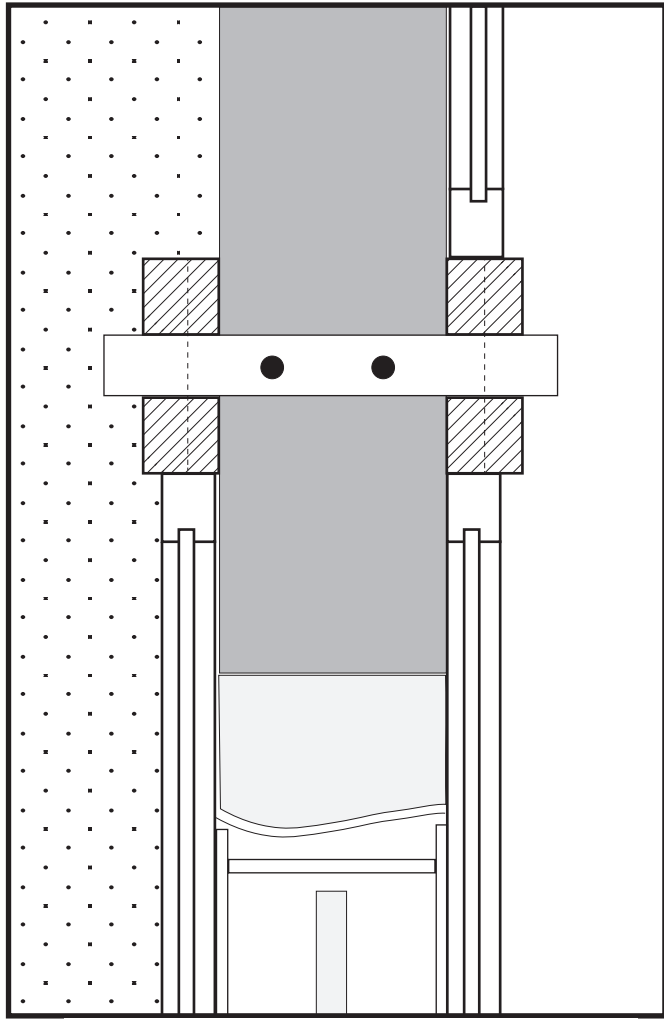

BOVEN

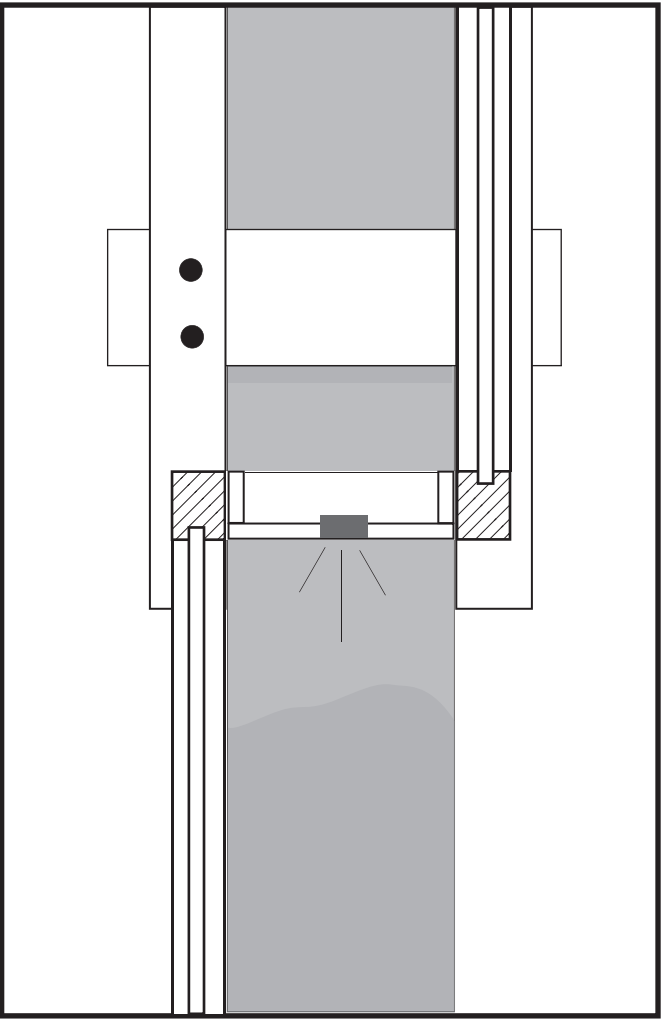

VOOR

Detail

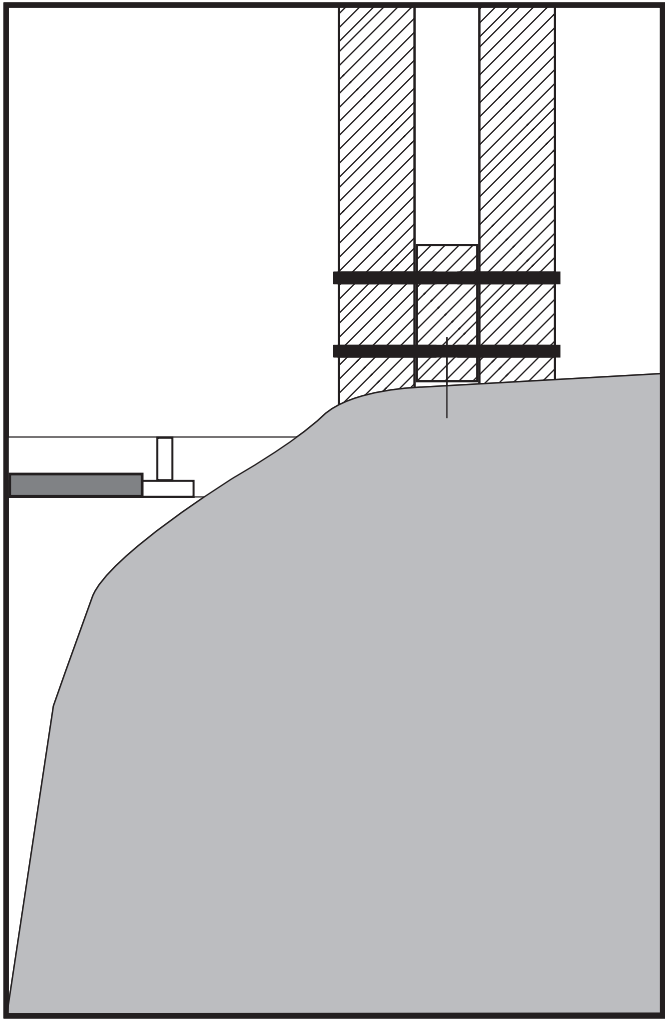

ZIJ