

# FUNCTIONELE FUNGI

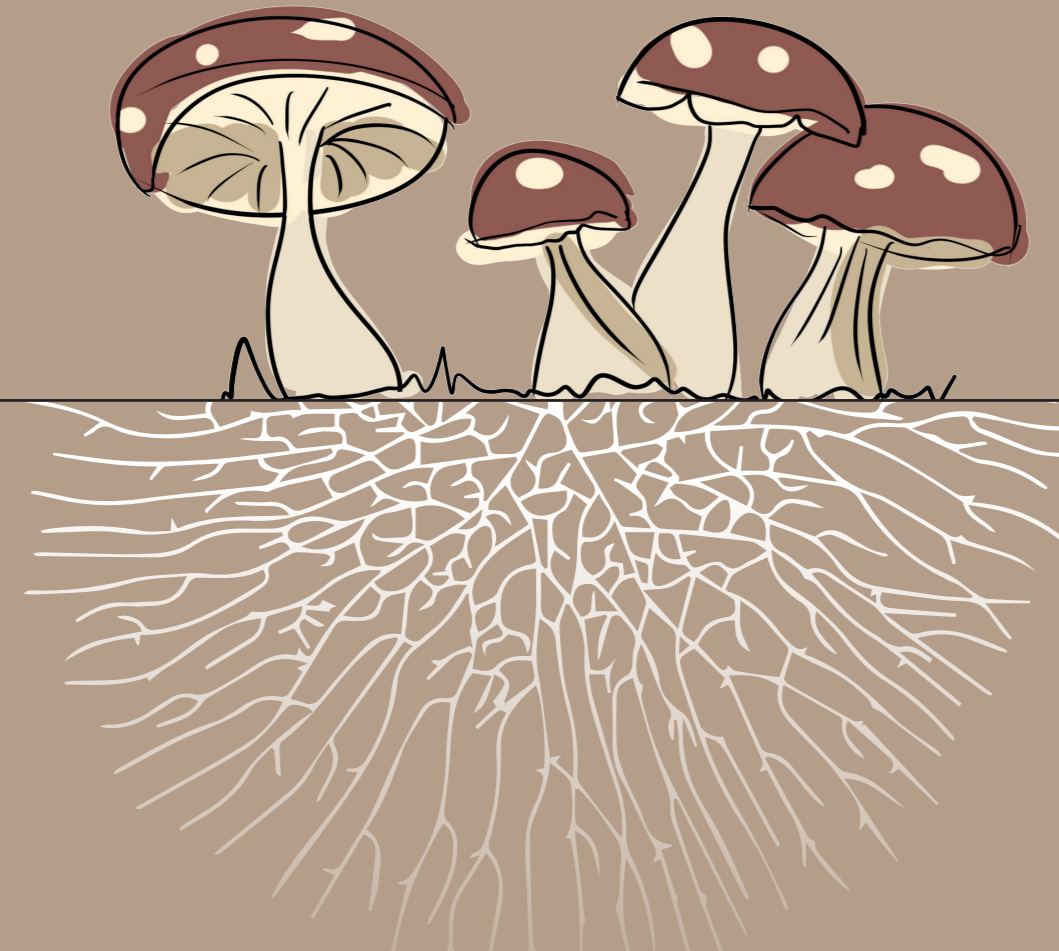

## WERKING MYCELIUM

Goed voor de natuur...

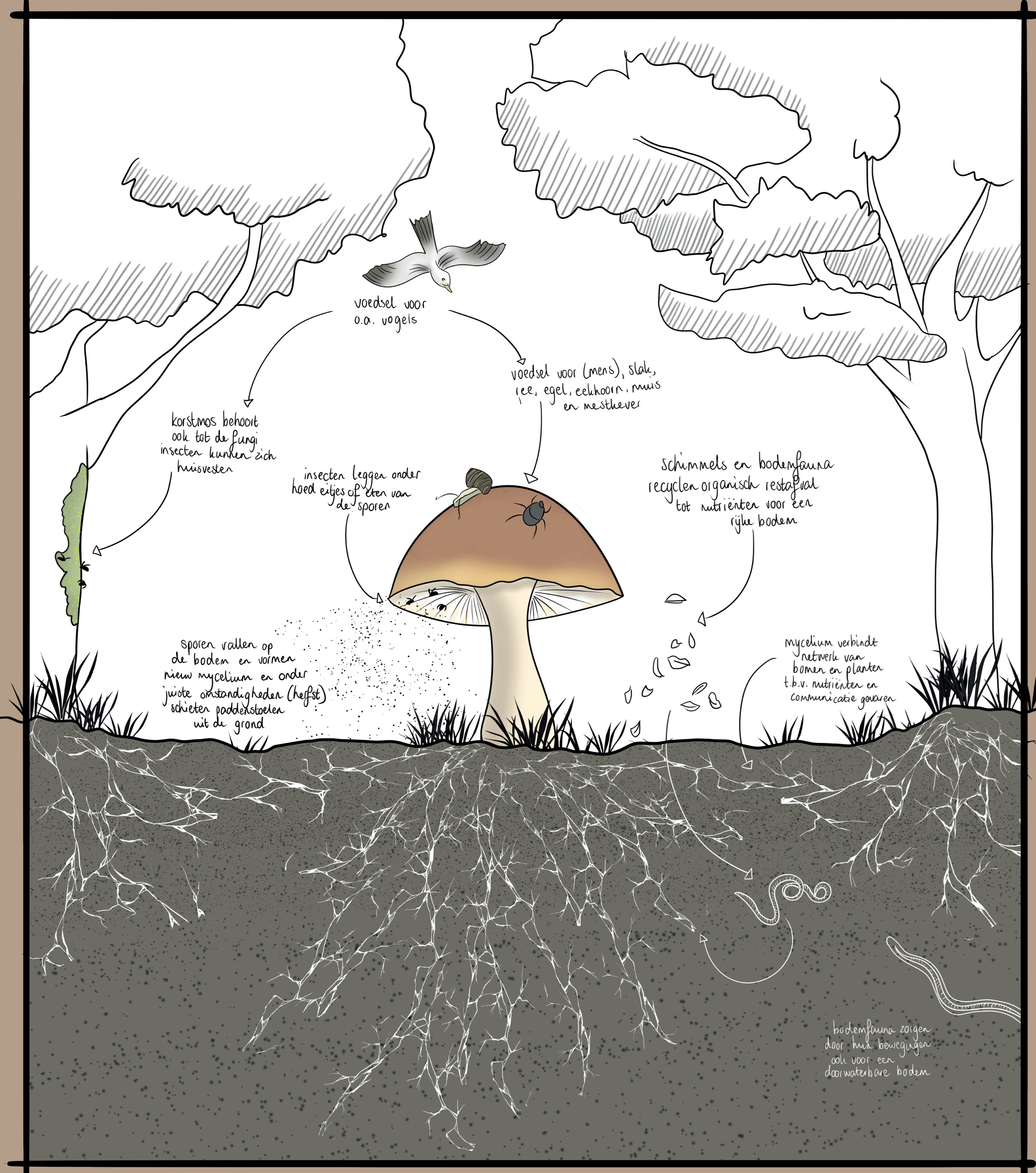

## PRODUCTIESHEMA

...en voor de mens

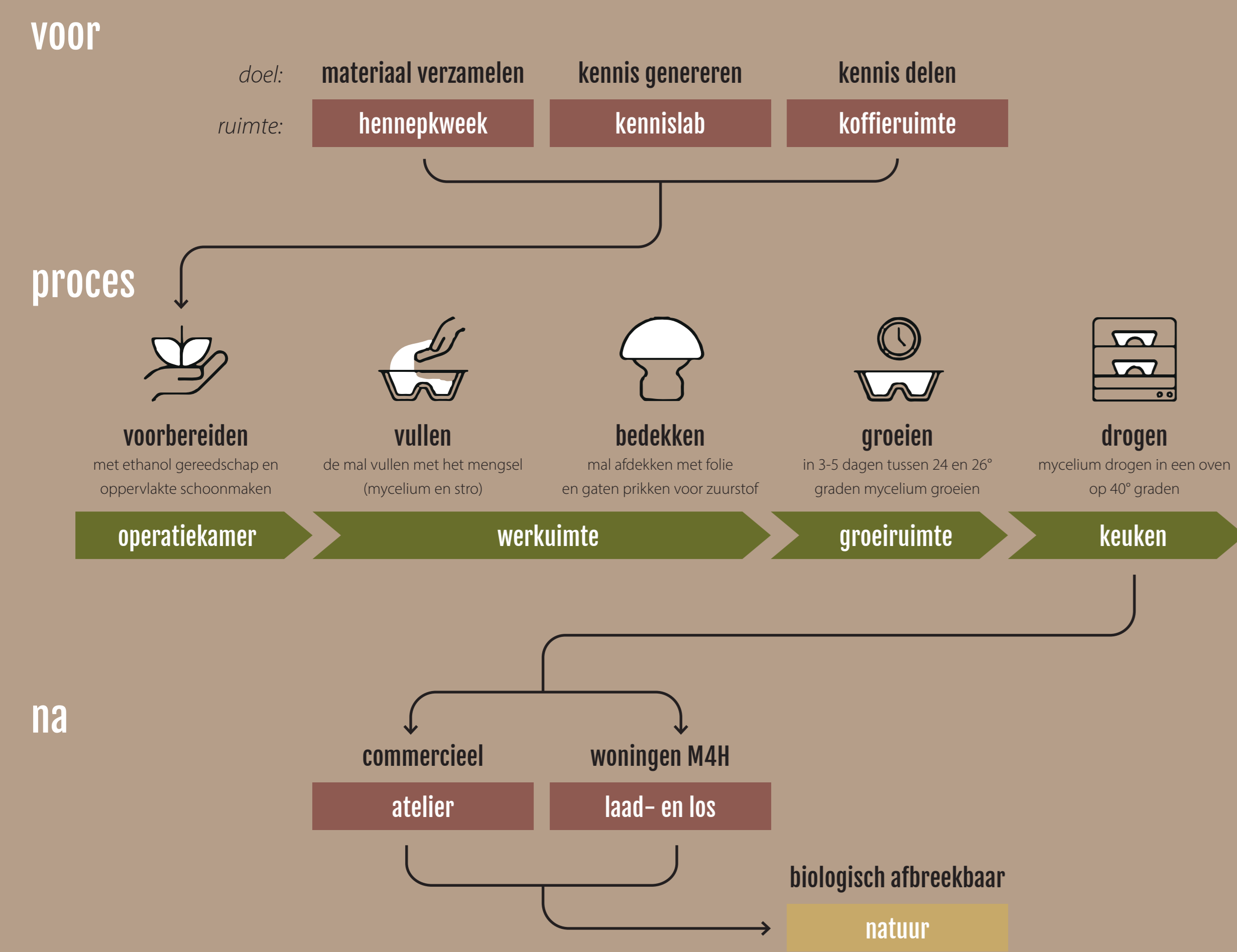

## VISIE M4H

productielandschap als verbinder

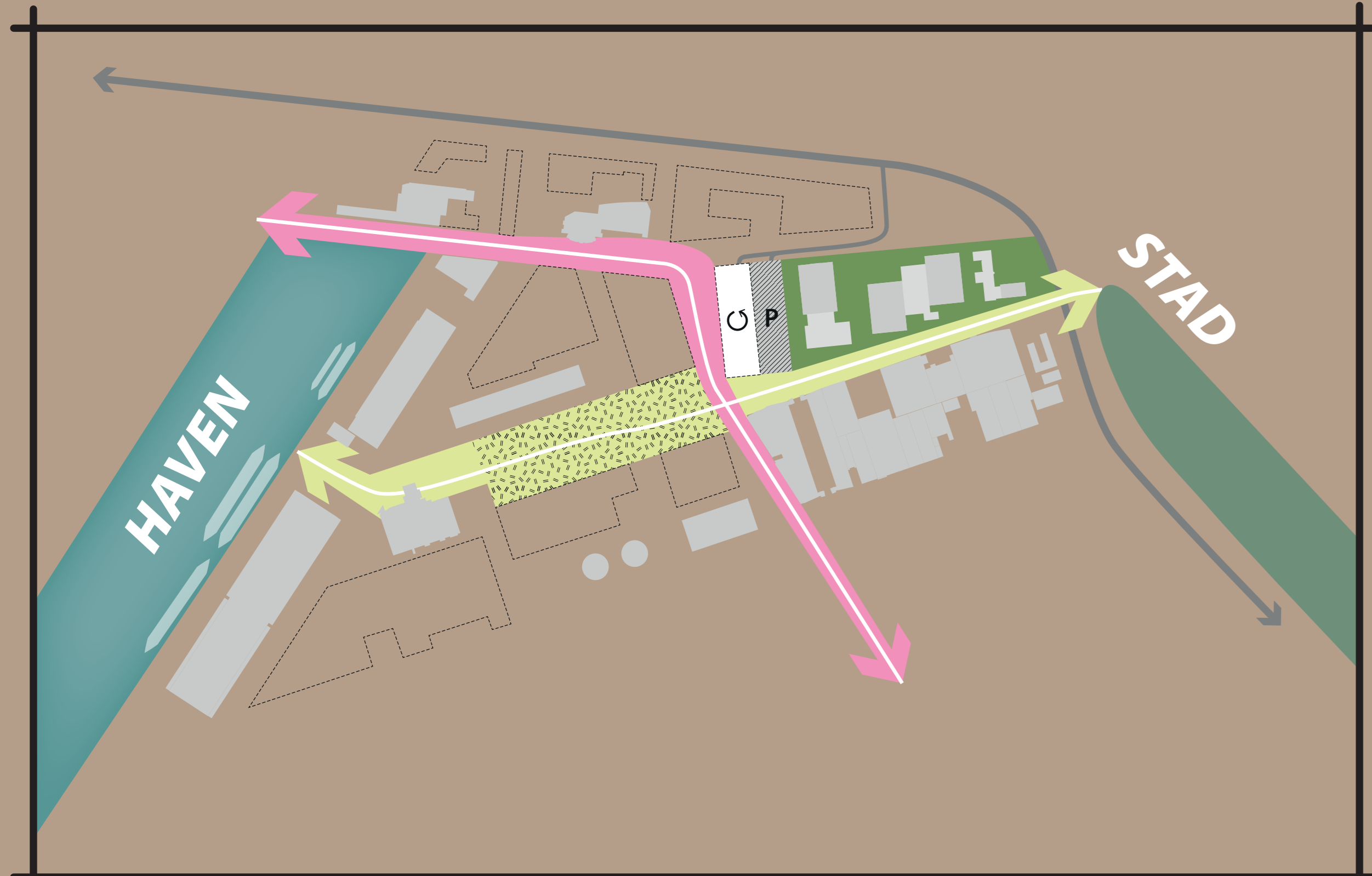

## OPZET HUB

Van massief gebouw naar open myceliumfabriek

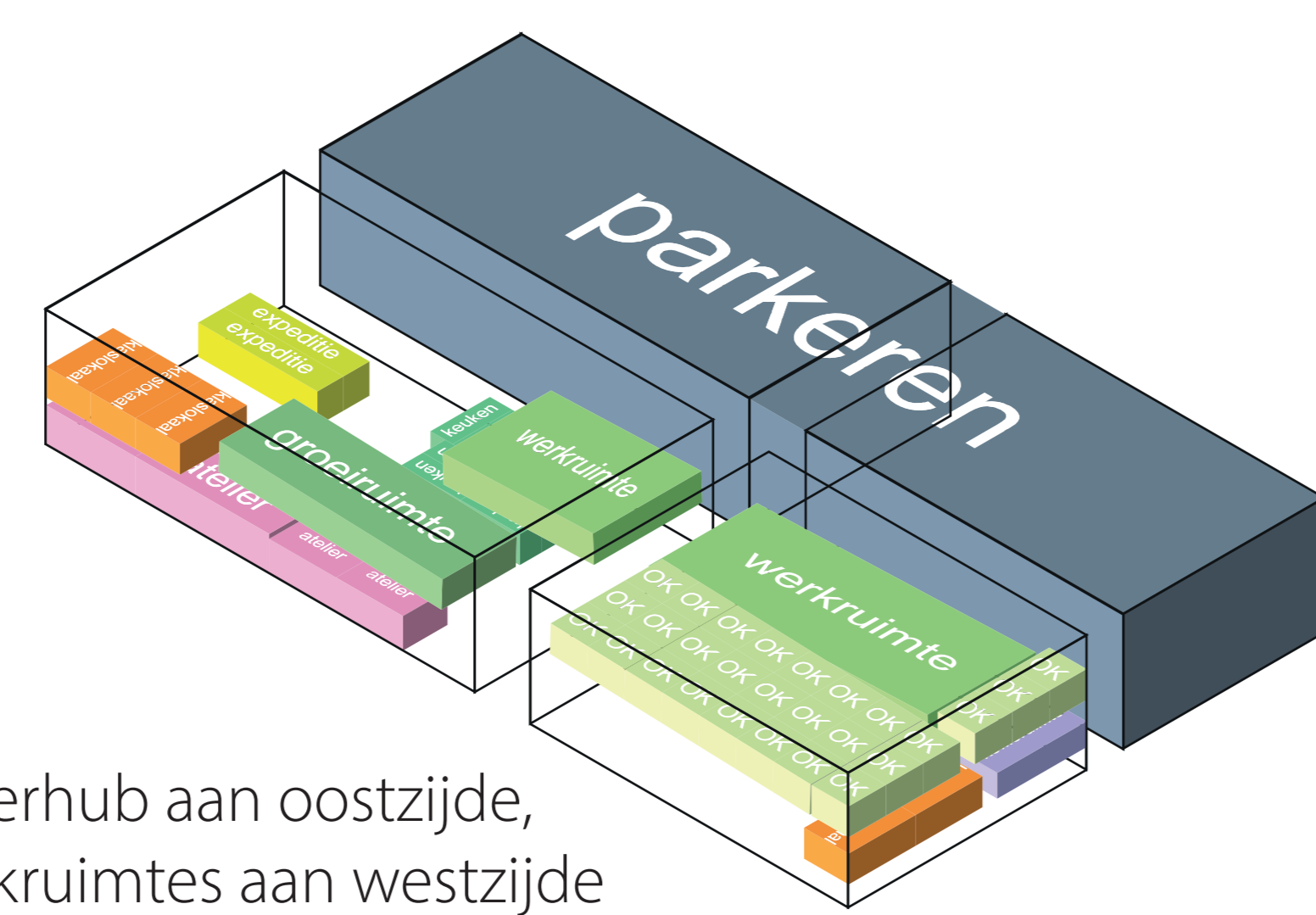
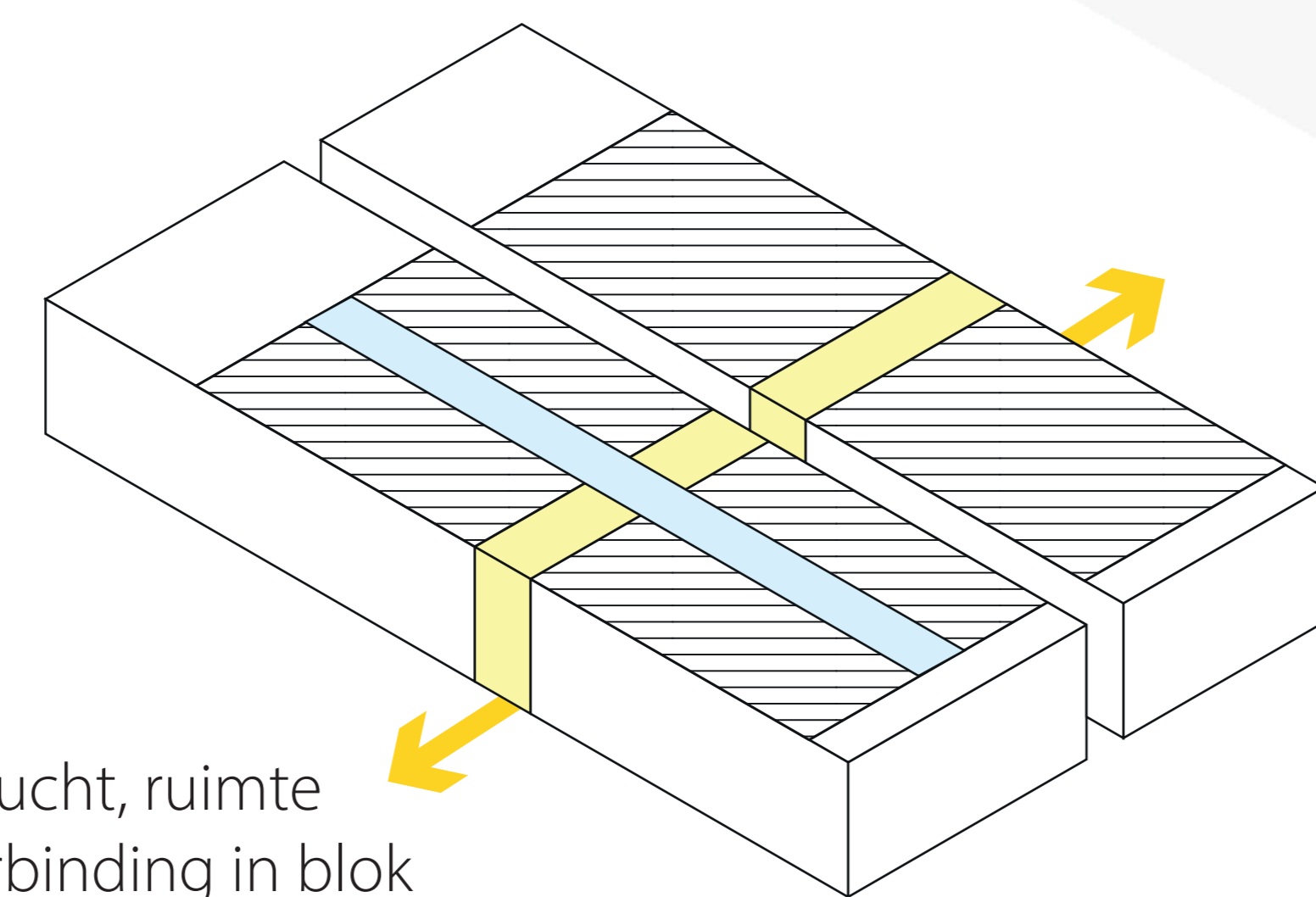
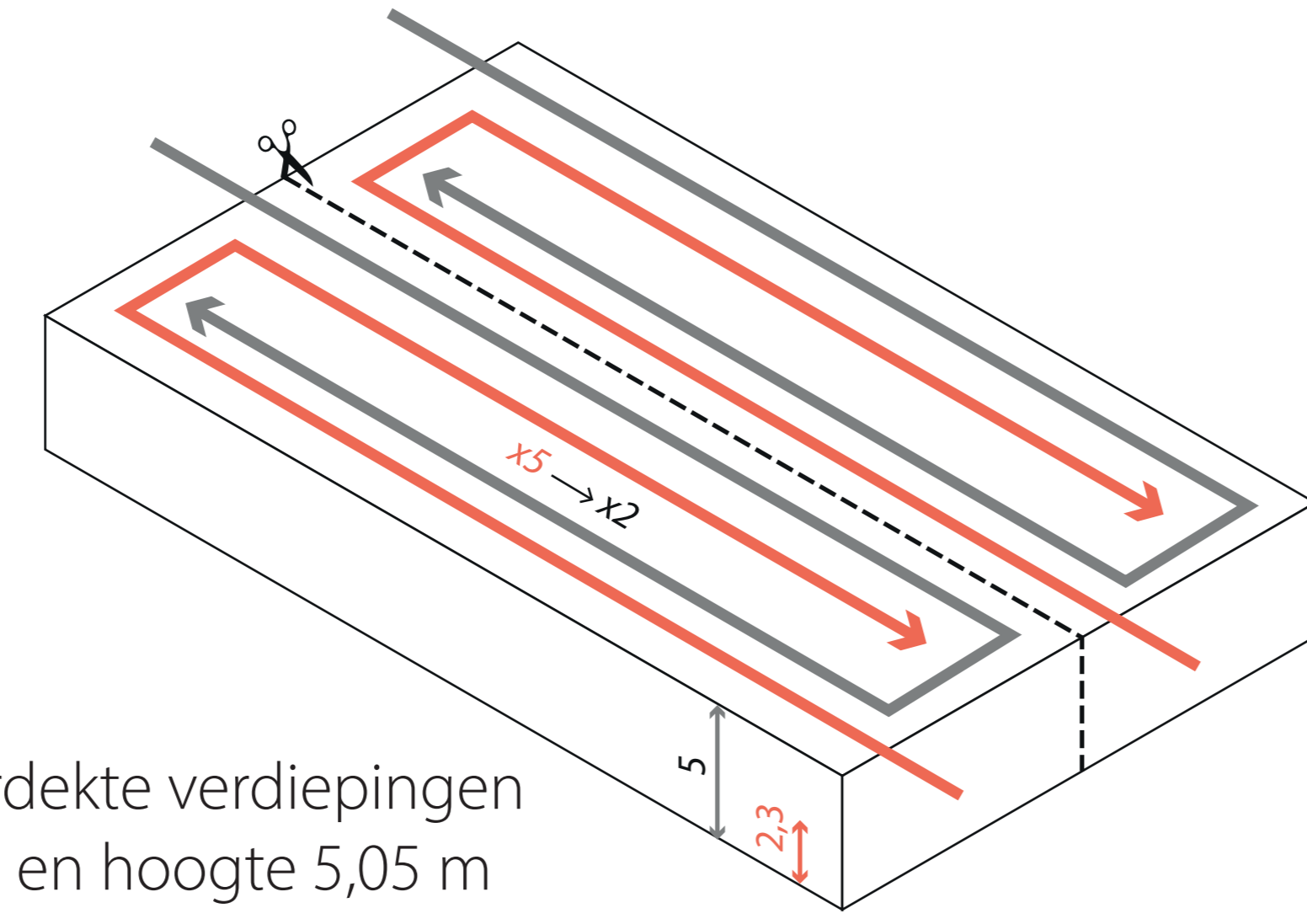

3 SEDUMDAK

2 OPERATIEKAMER  
3 WERKRUIJMT  
4 SEDUMDAK

5 WERKRUIJMT  
6 GROEIRUIJMT  
7 KOFFIERUIJMT  
8 KENNISLAB

9 KEUKEN  
10 ATELIER  
11 LAAD- EN LOS  
12 KOFFIERUIJMT  
13 ENTREE

14 HENNEPKWEEK

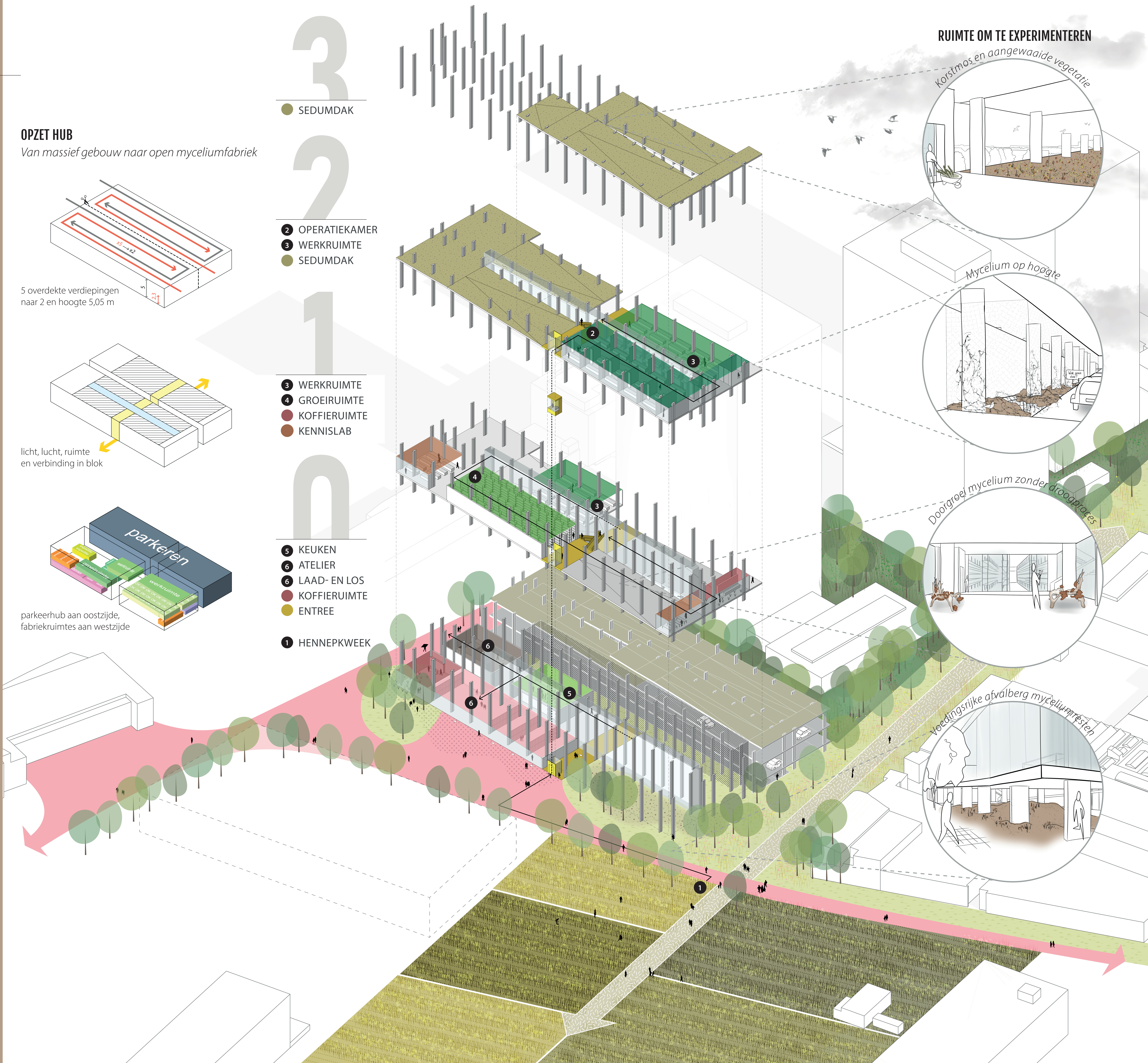

## RUIMTE OM TE EXPERIMENTEREN

Koersmos en aangeweide vegetatie

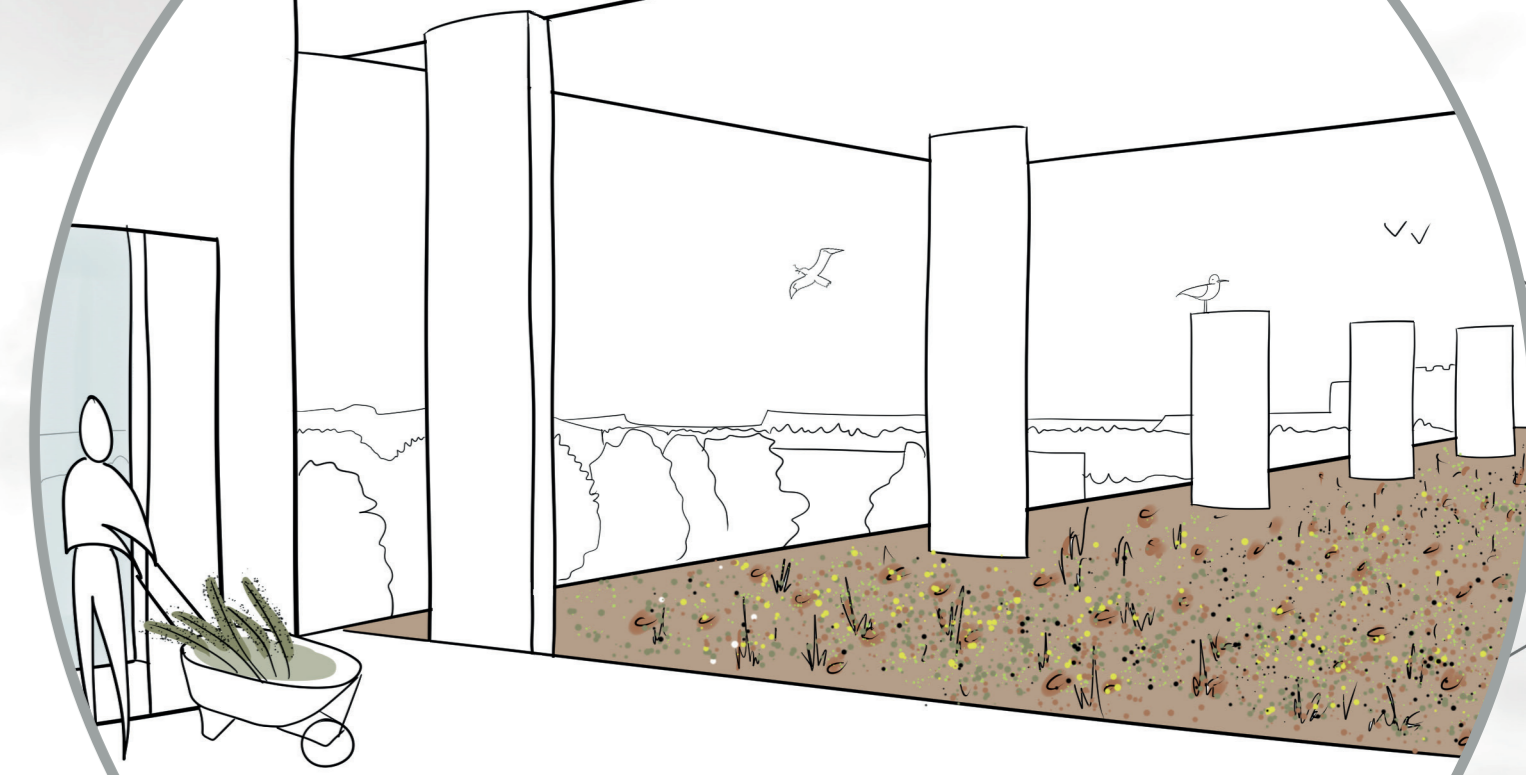

Mycelium op hoogte

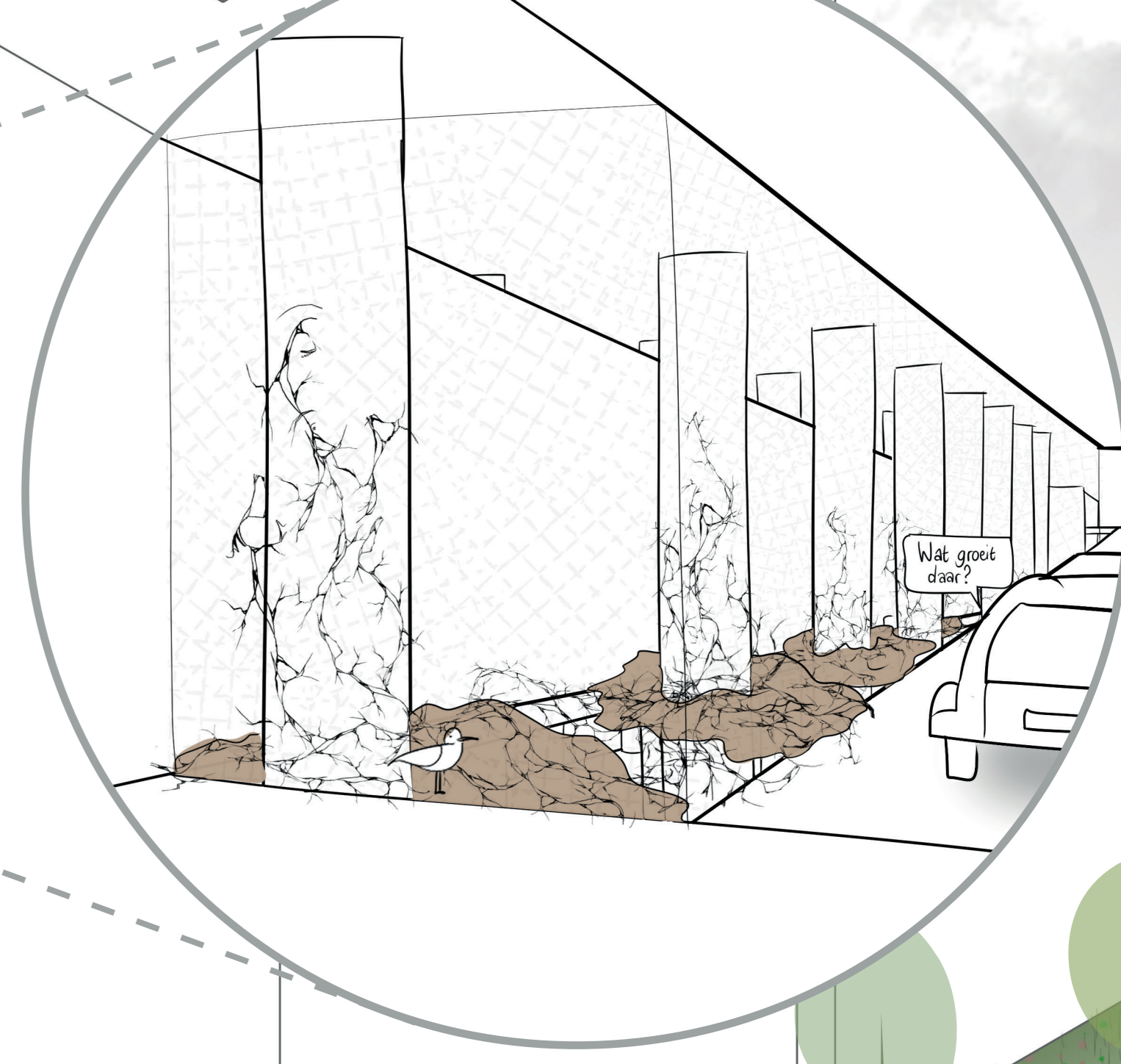

Doorgroei mycelium zonder droogprobes

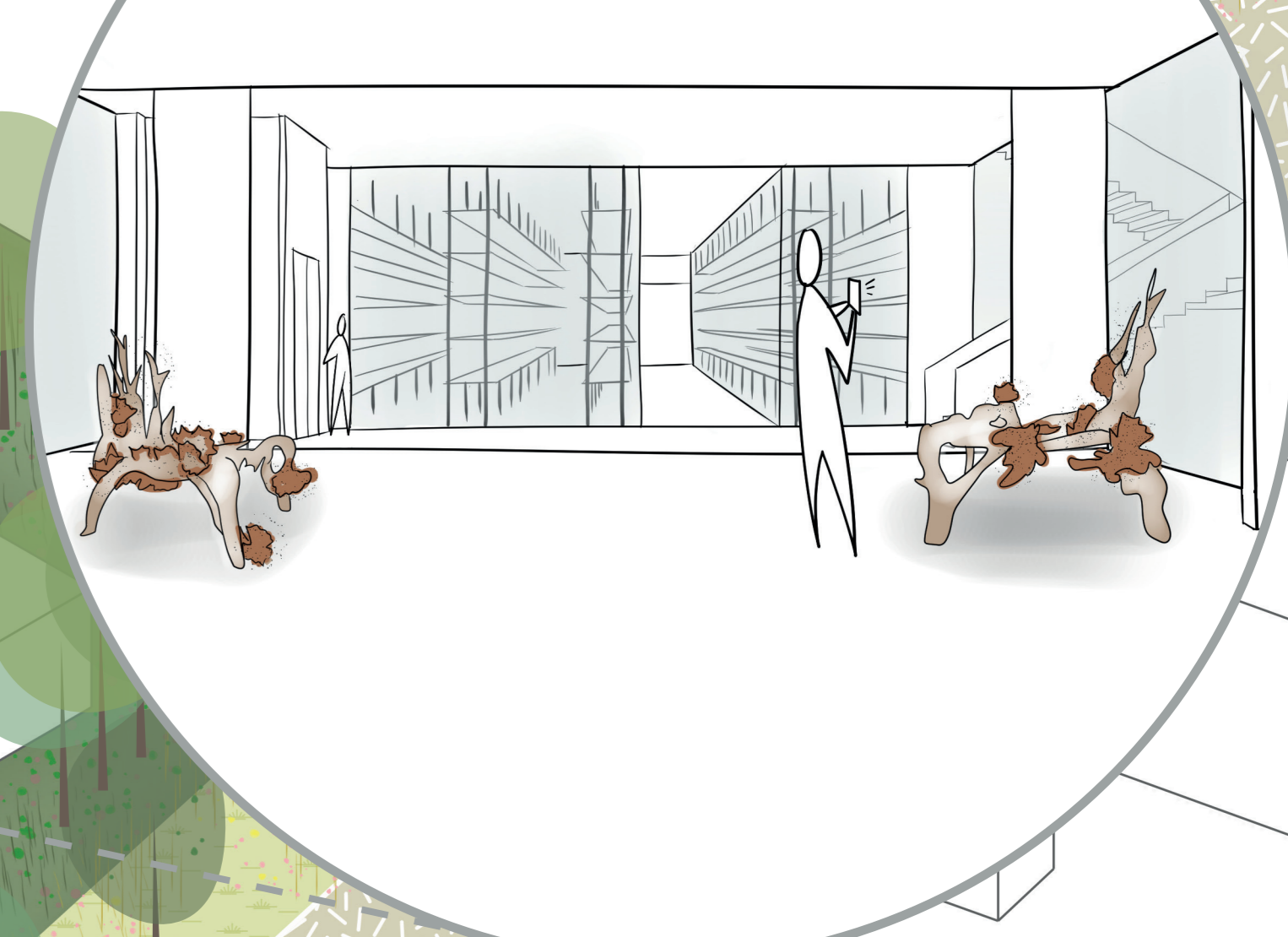

Voedingsrijke afvalberg mycelium resten

