

# De oase van Hoek van Holland



David Steijger



# Doelgroep

Kinderen met prikkel verwerking stoornis



Burn-out slachtoffer





# Concept

## Het Hofje

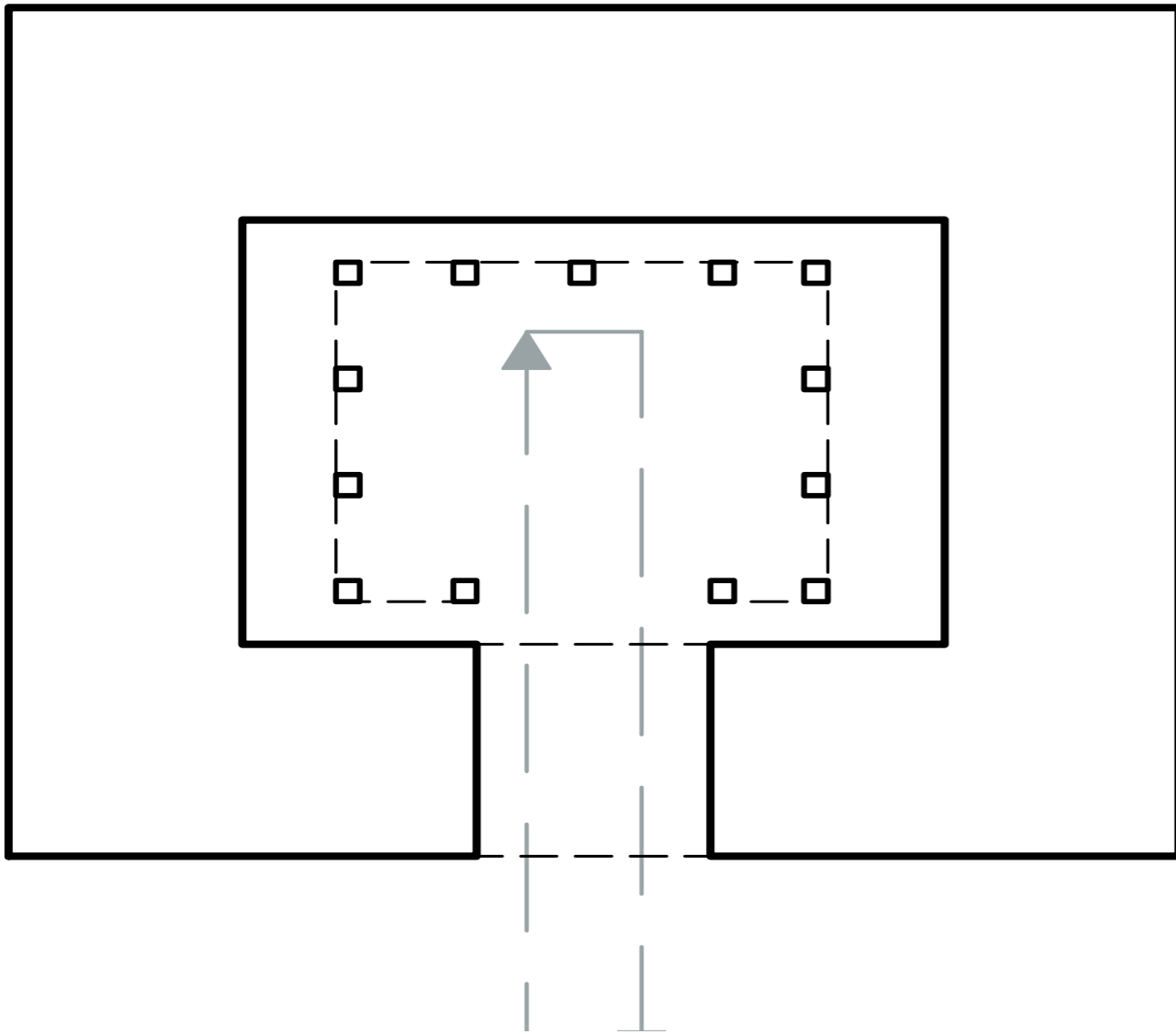

Abdij van Roosenberg, Waasmunster  
Dom Hans van der Laan

# Concept

Het Hofje

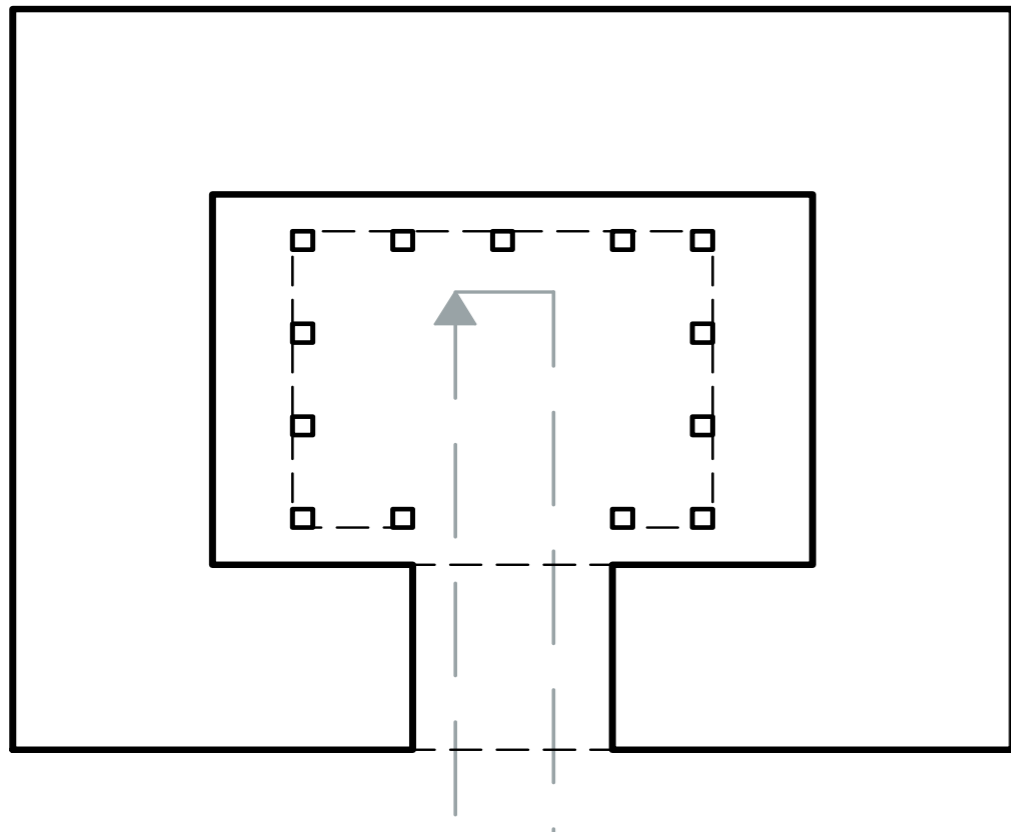

Hofjes aan een route

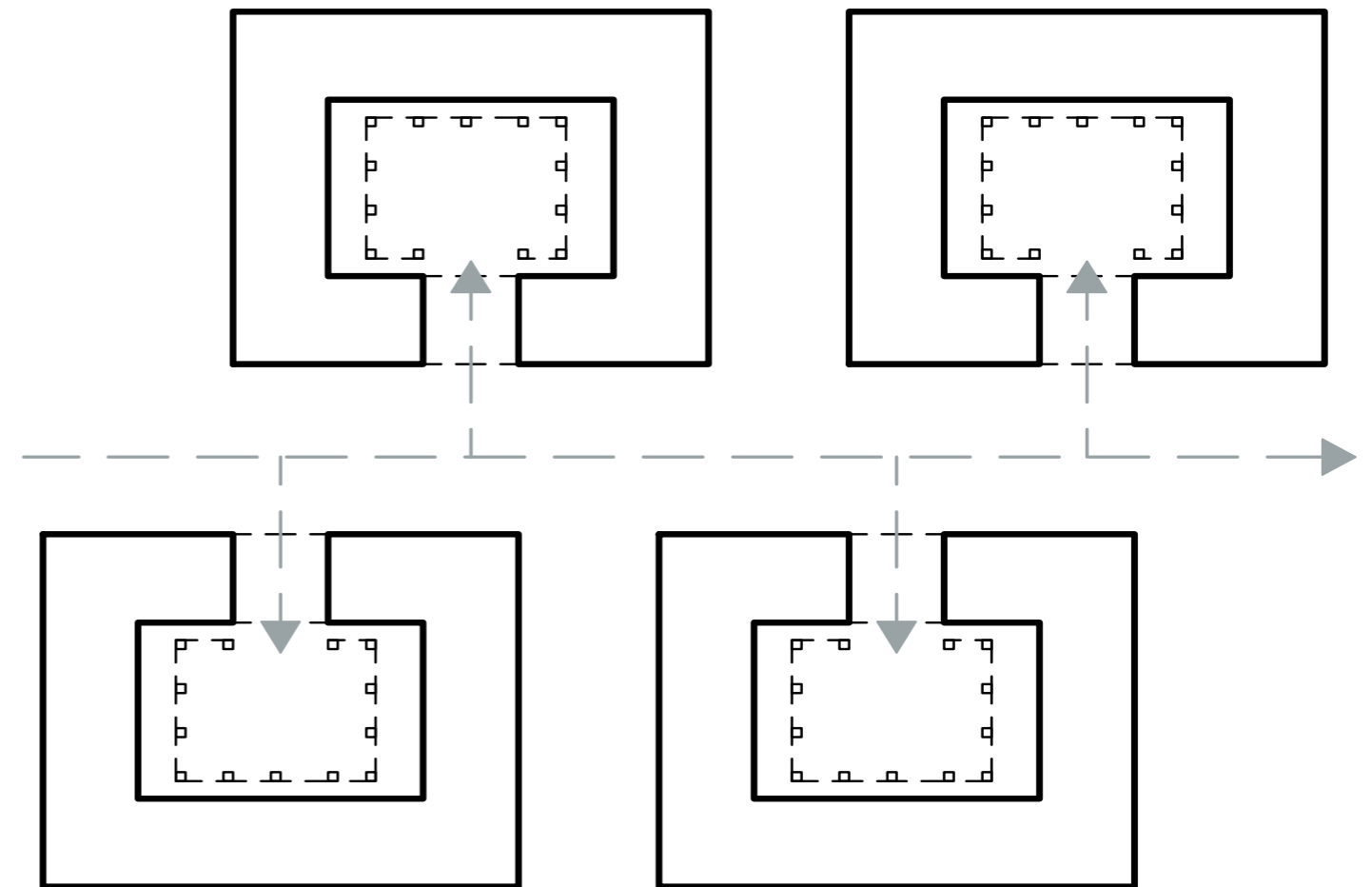



# Concept

## Hofjes aan een route

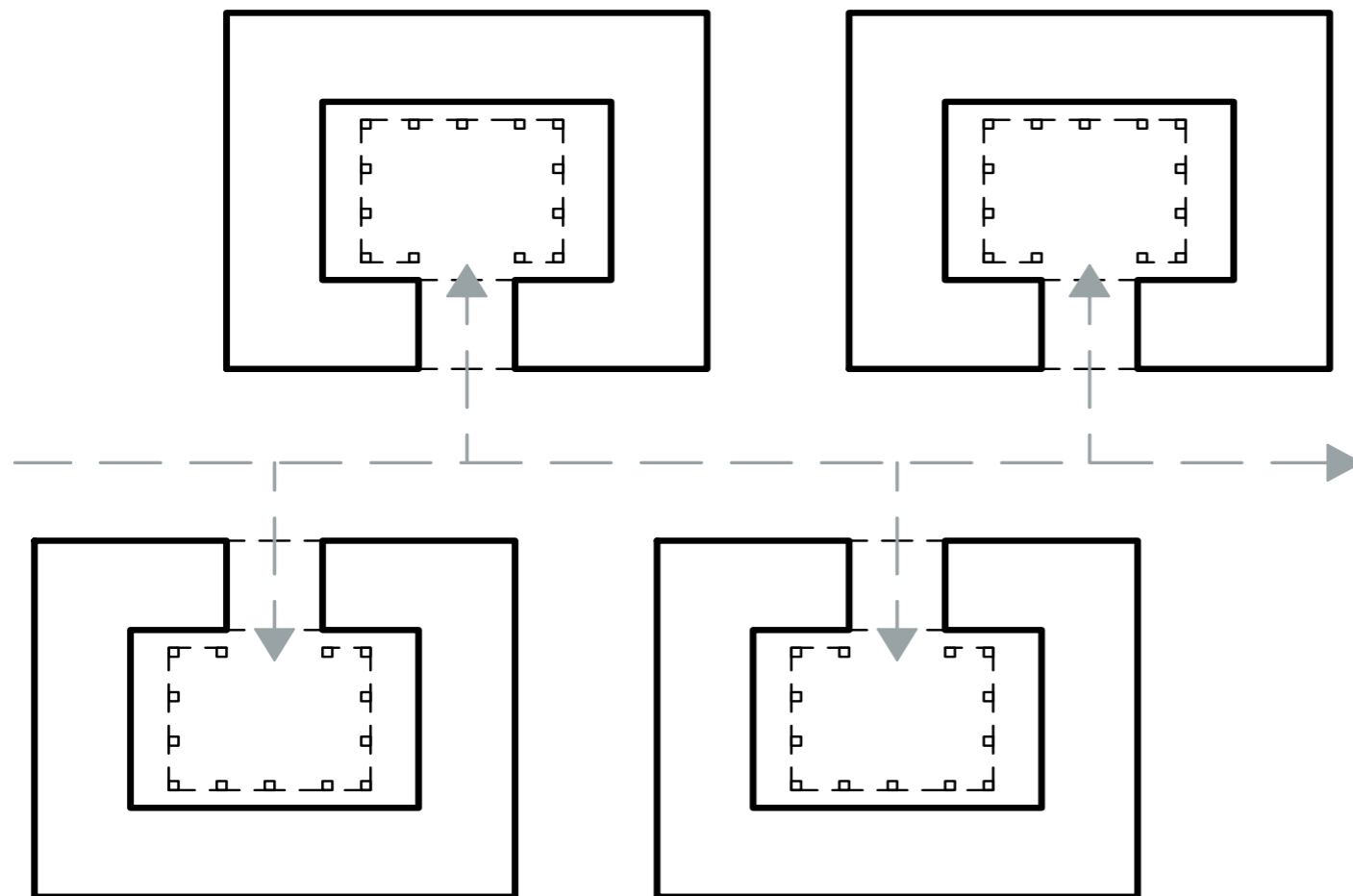

## Hofjes in de context

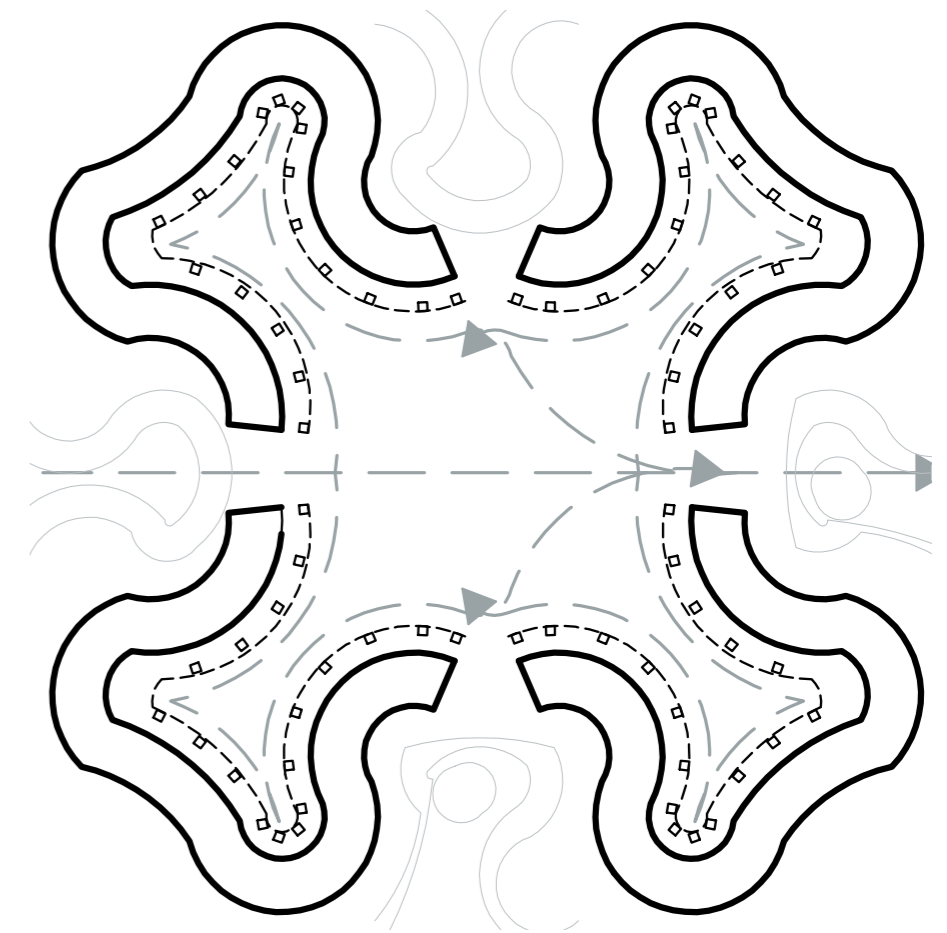



# Concept

Hofjes in de context

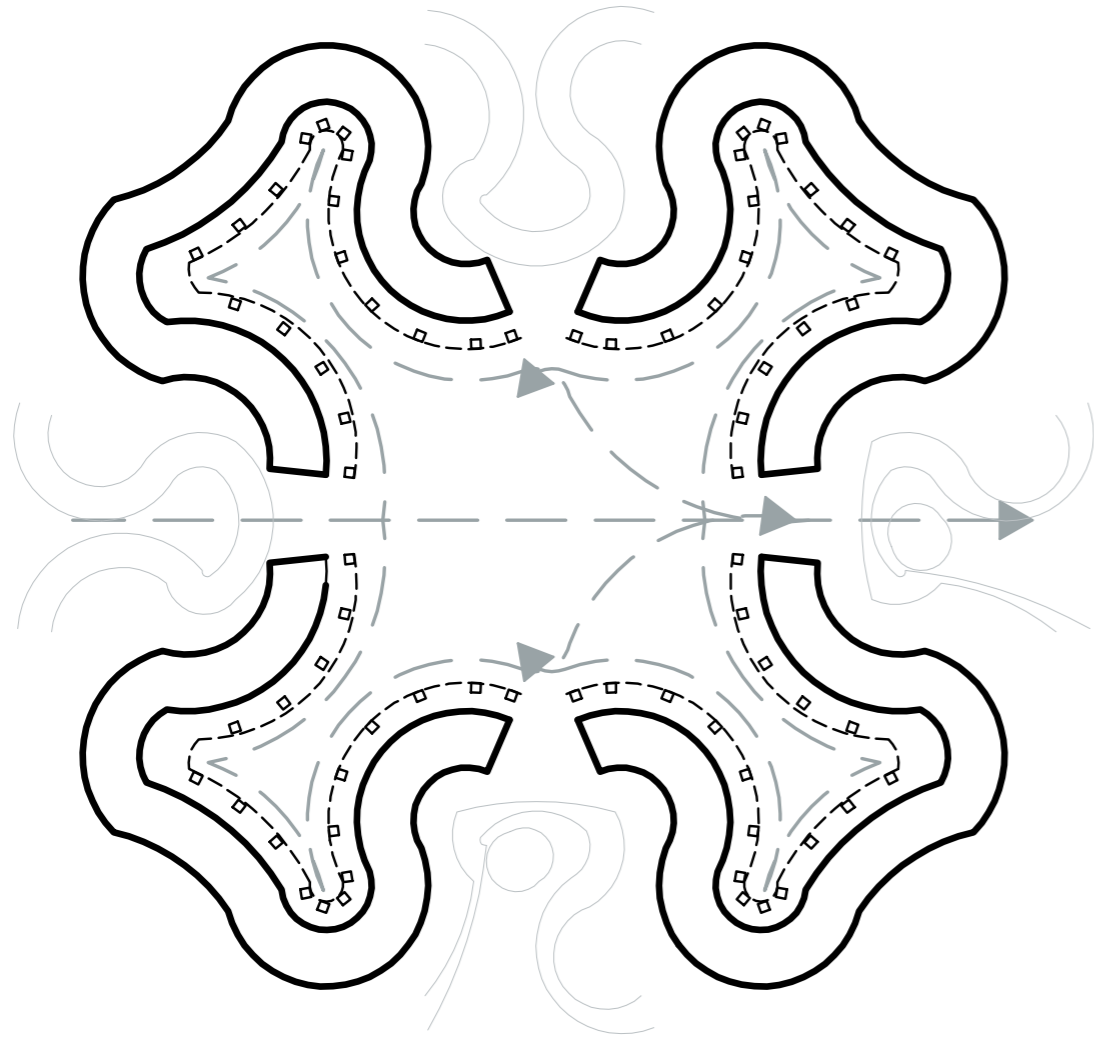

Hofjes aan één route

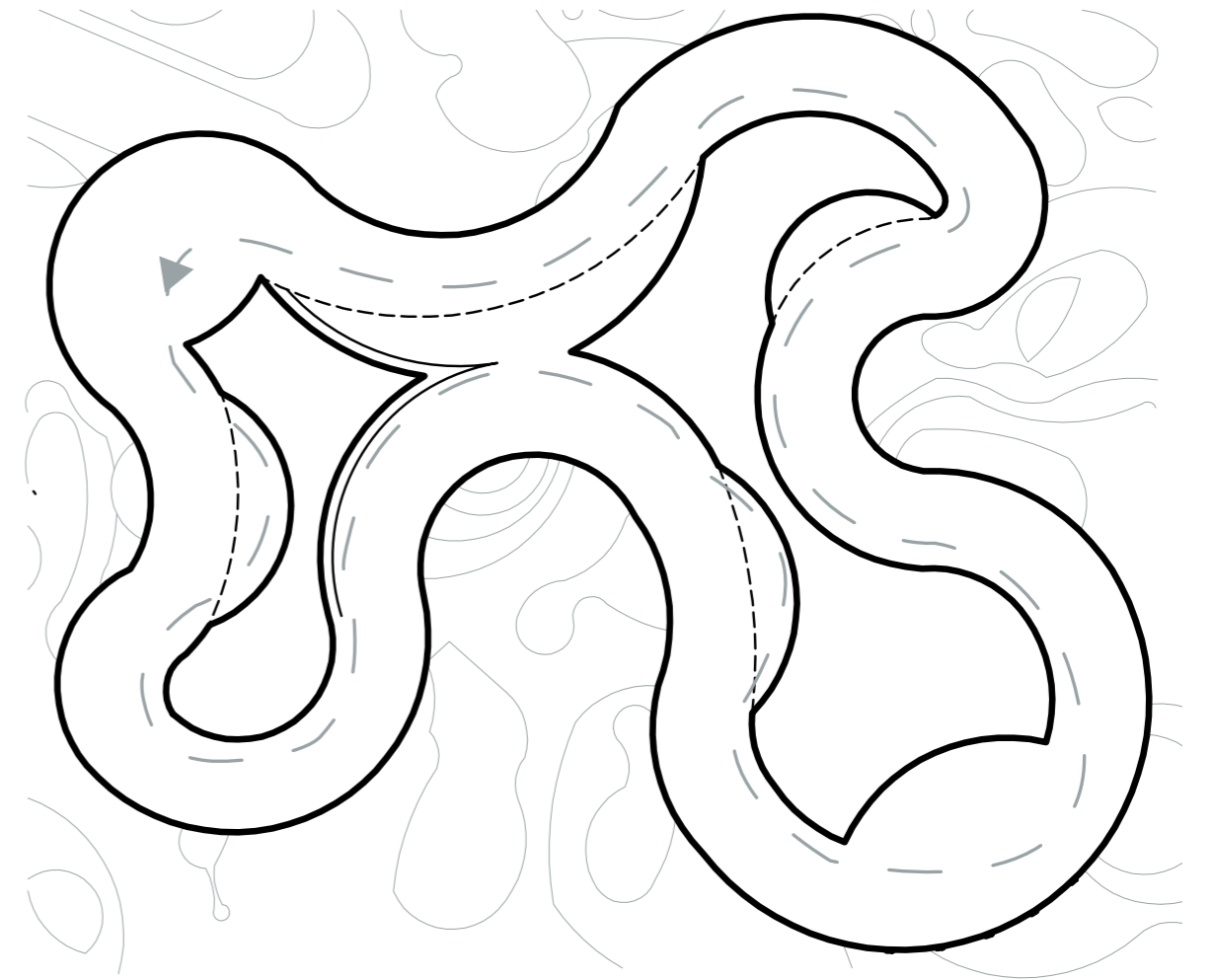



# Situatie 1:2000





# Situatie 1:1000



1. vakantie huisjes



2. Verschillende hoogtes duinen



3. Doorgang duinen





# Plattegrond 1:200

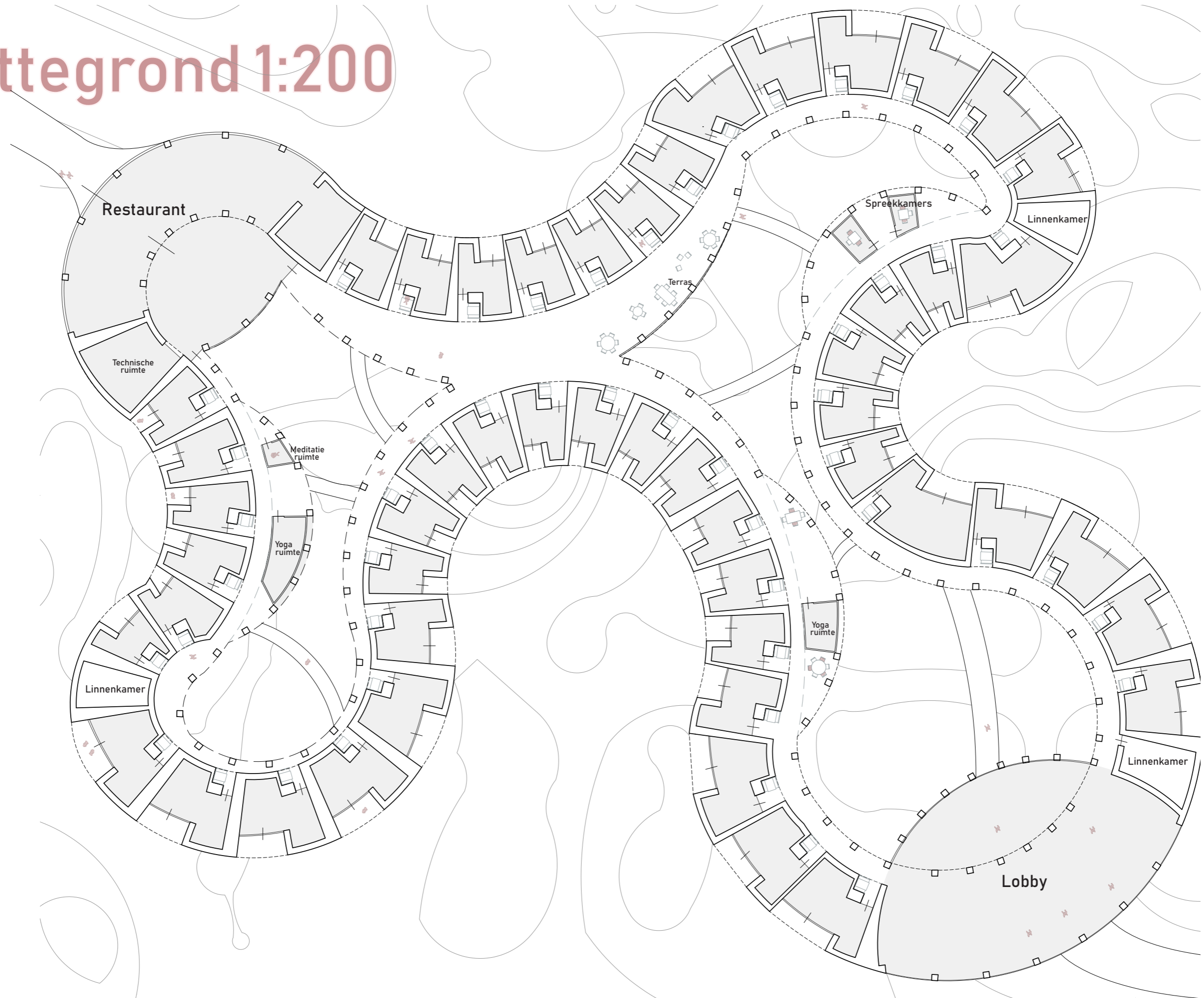



# Doorsnede 1:50

## A-A

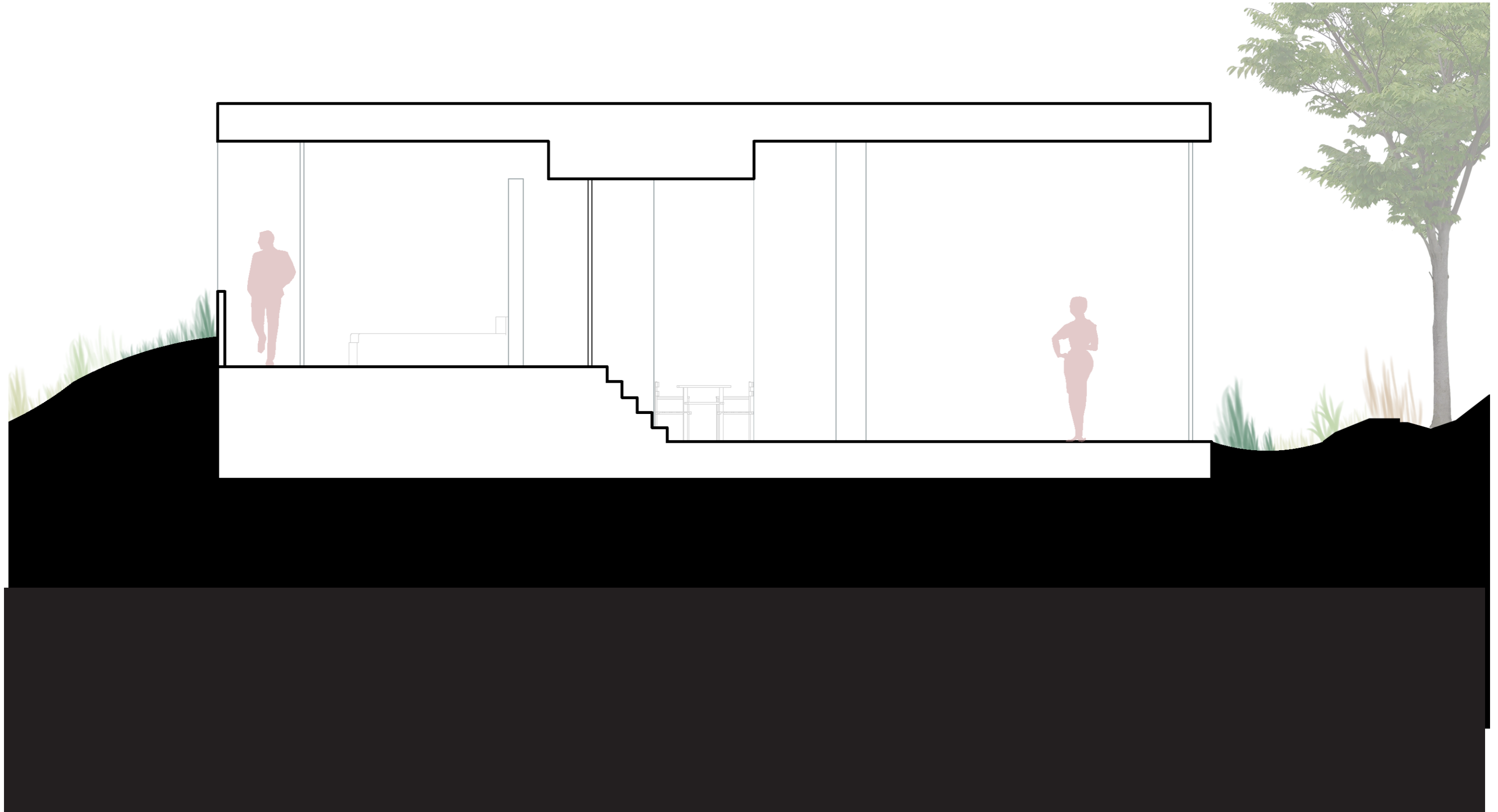
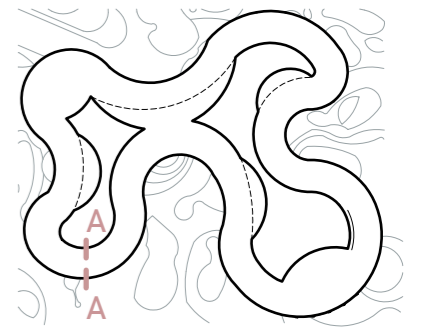



# Doorsnede 1:50

## B-B

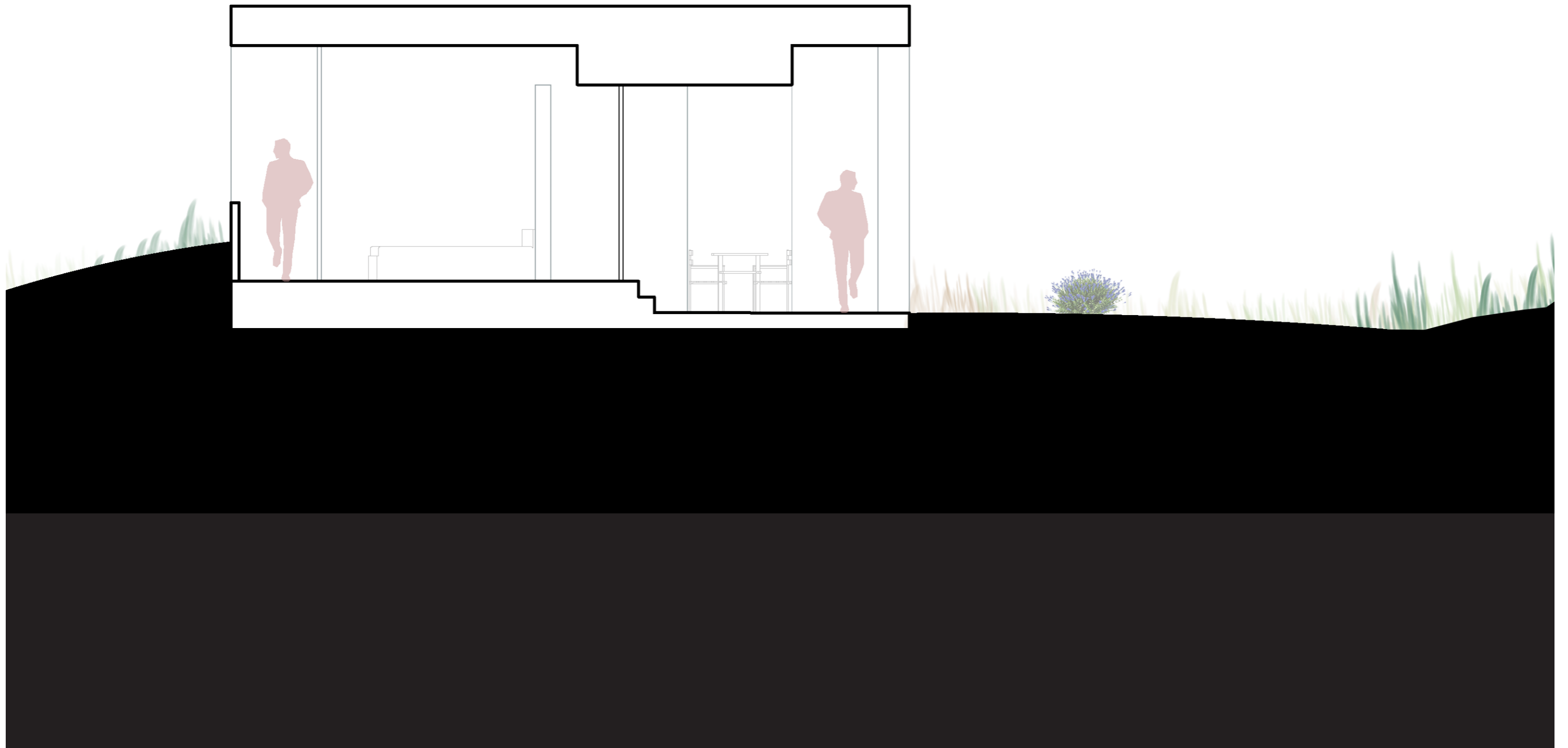
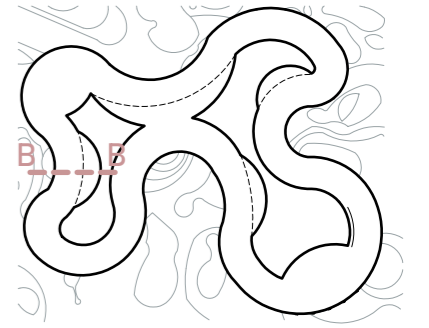



# Doorsnede 1:50 C-C

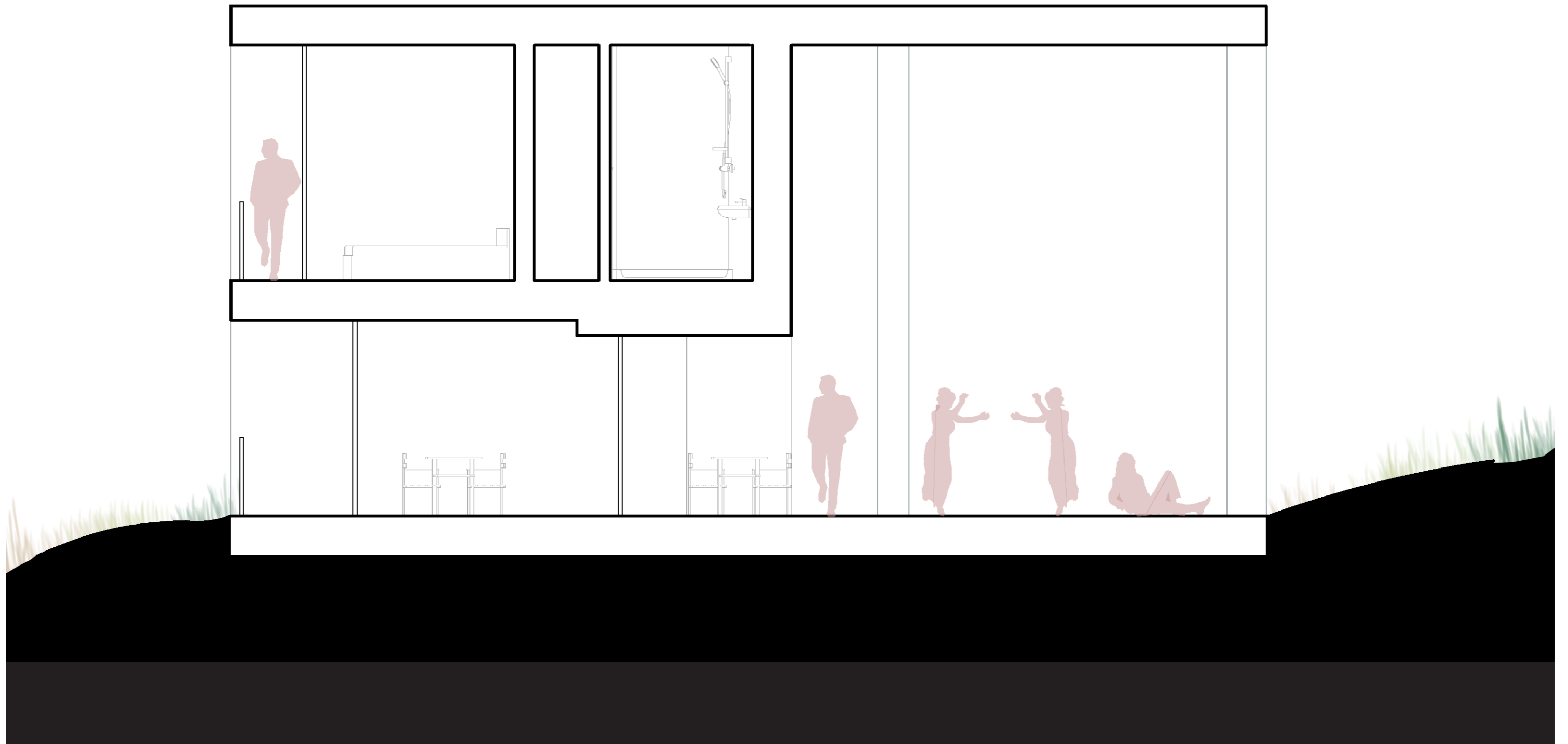
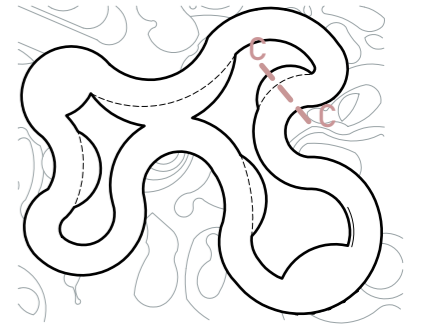



# Doorsnede 1:100

## D-D

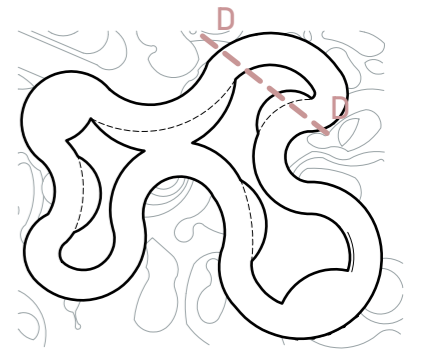

# Gevel 1:100





# Fragment

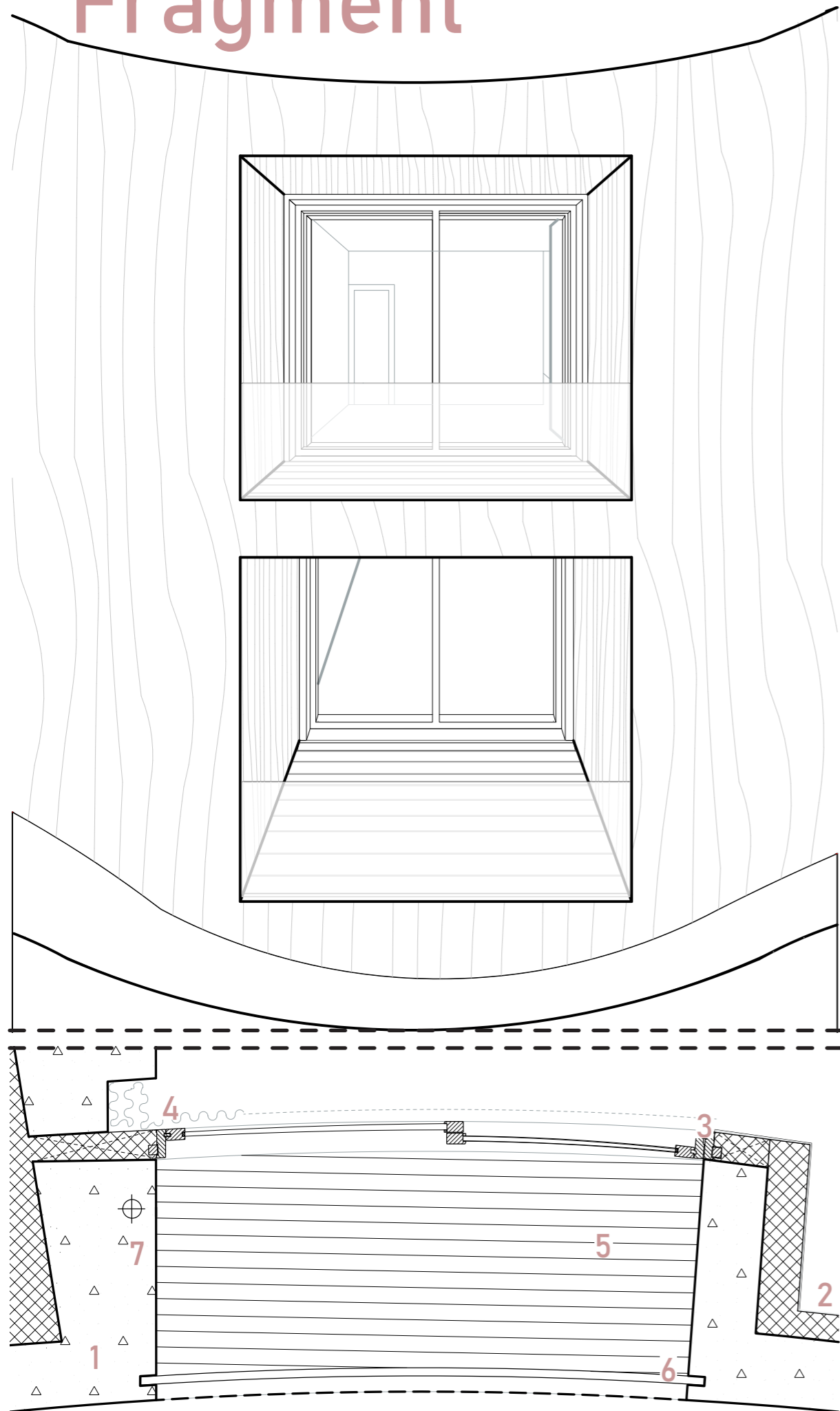

1. i.h.w. gestort beton
2. Hoogwaardige isolatie
3. Houten schuifpui
4. Gordijn met rails
5. Houten terras
6. glazen balustrade
7. HWA in beton gestort

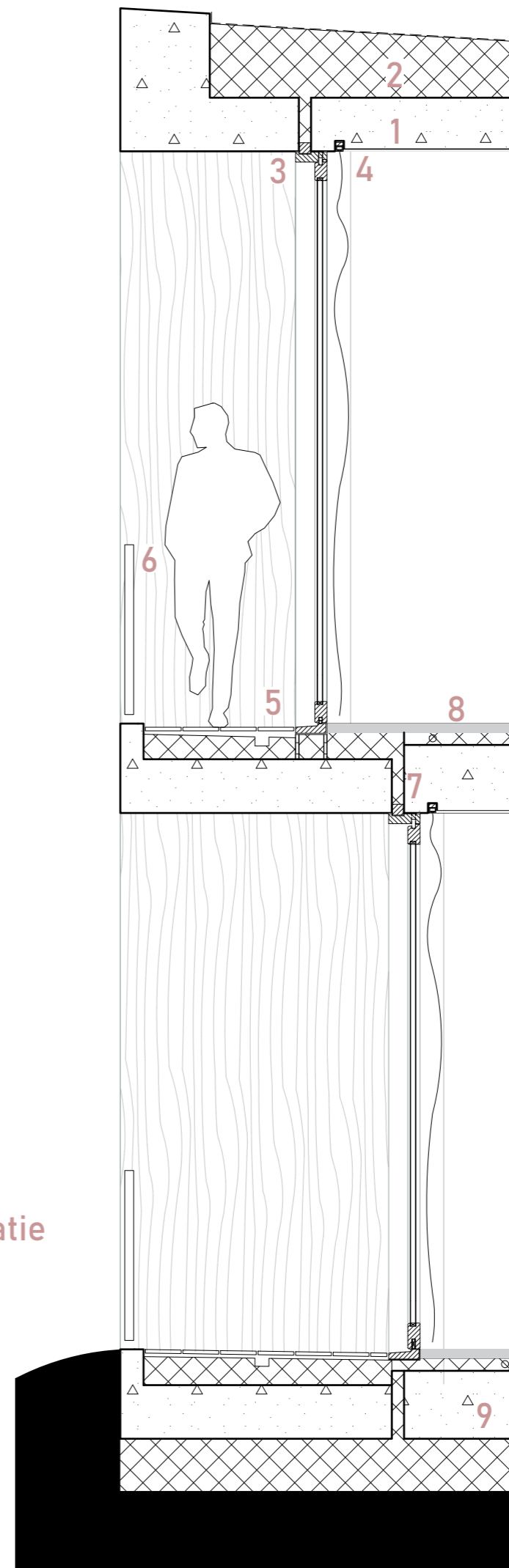

1. i.h.w. gestort beton
2. Isolatie onder afschot
3. Houten schuifpui
4. Gordijn met rails
5. Houten terras
6. glazen balustrade
7. Hoogwaardige isolatie
8. Vloerverwarming
9. i.h.w. gestorte vloer met verloren bekisting



# Impressie





# Impressie





# De oase van Hoek van Holland

