

# Cluster Zuid

Primary school in Zuidwijk

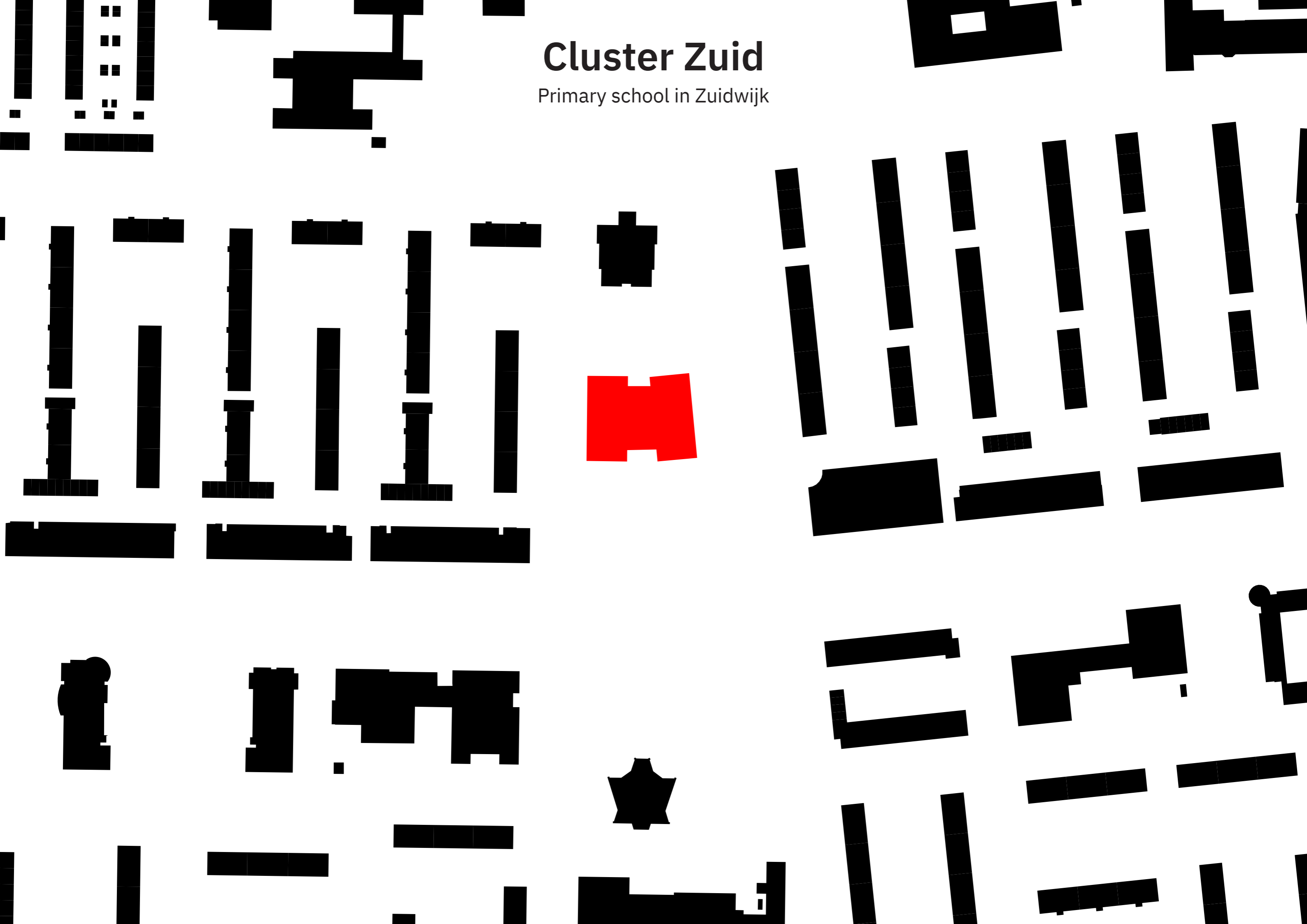

# Concept Diagram

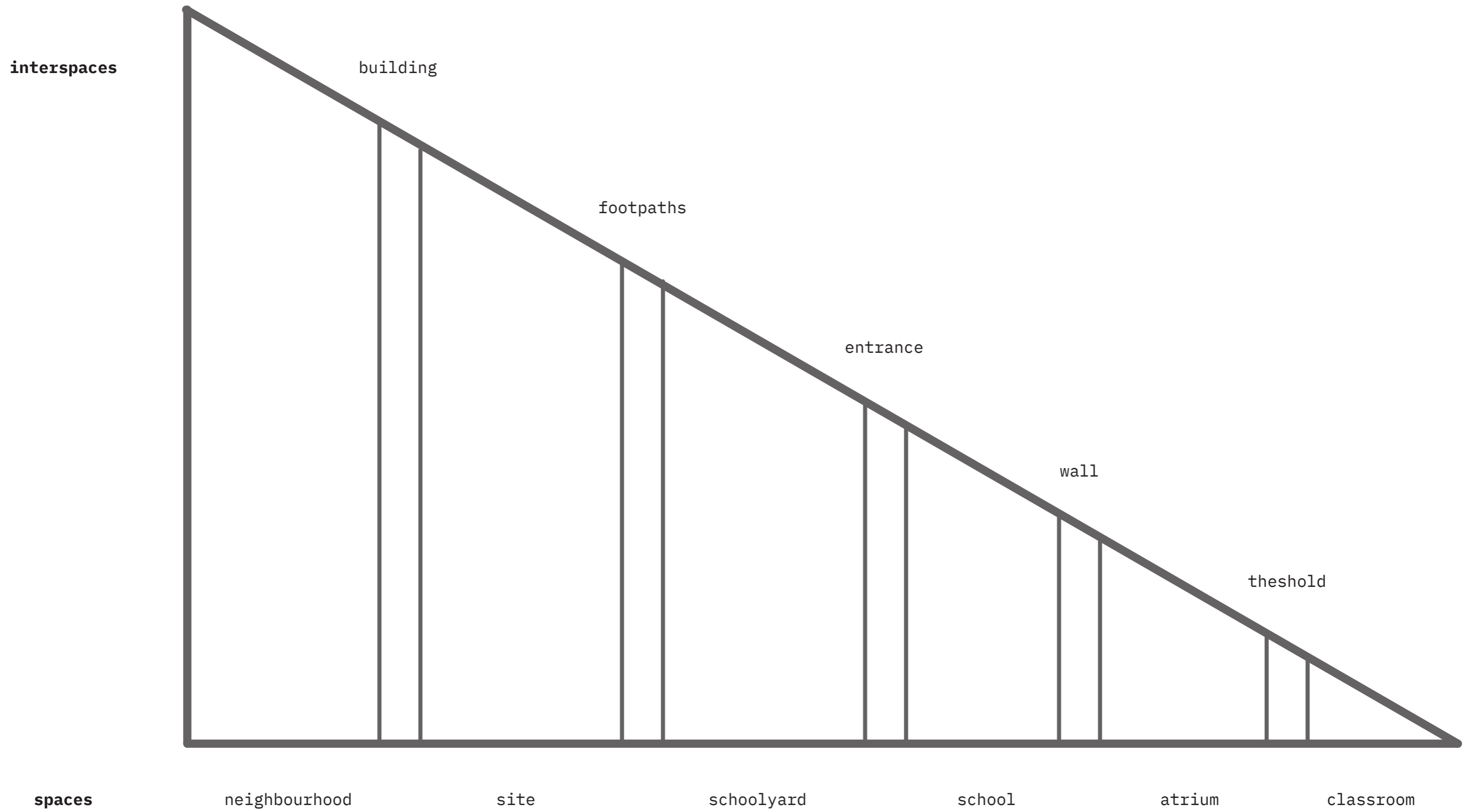

# Massing

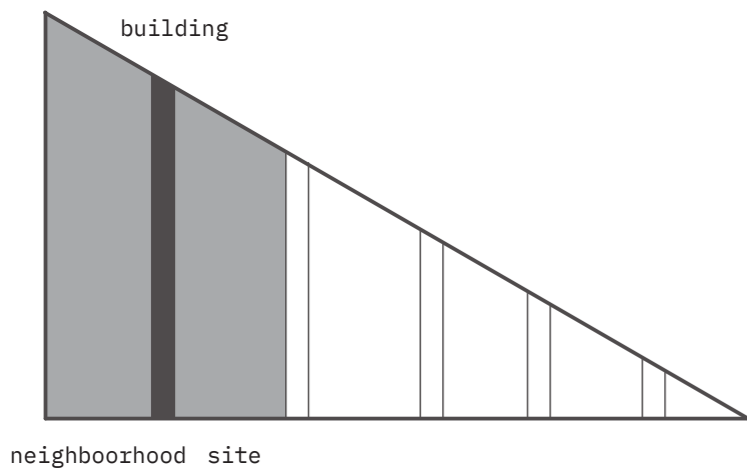
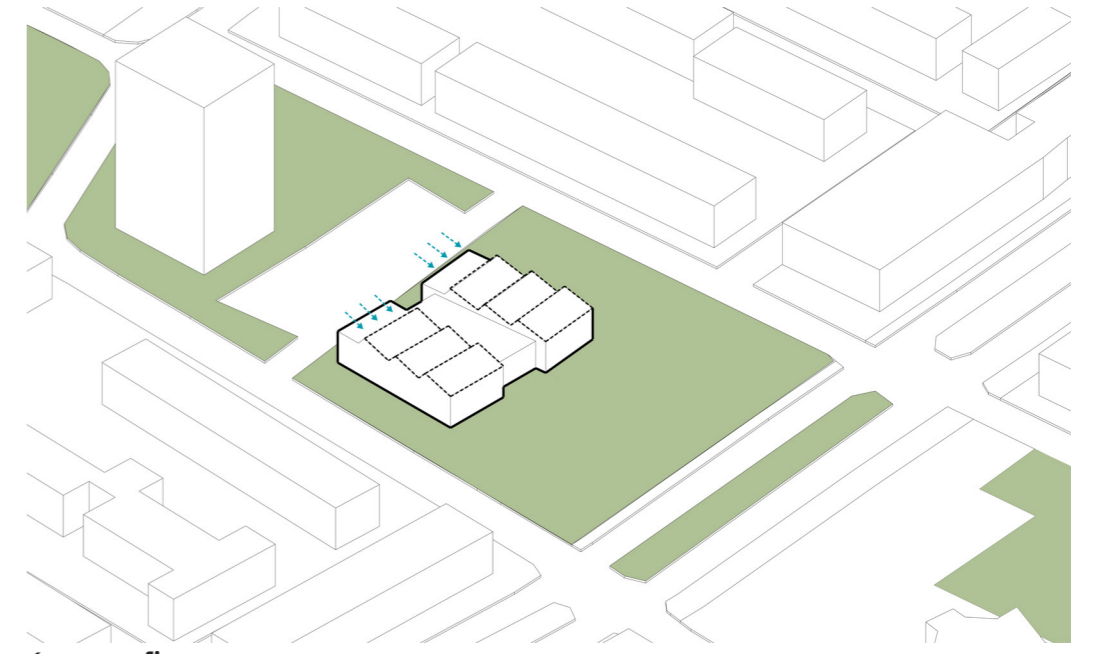
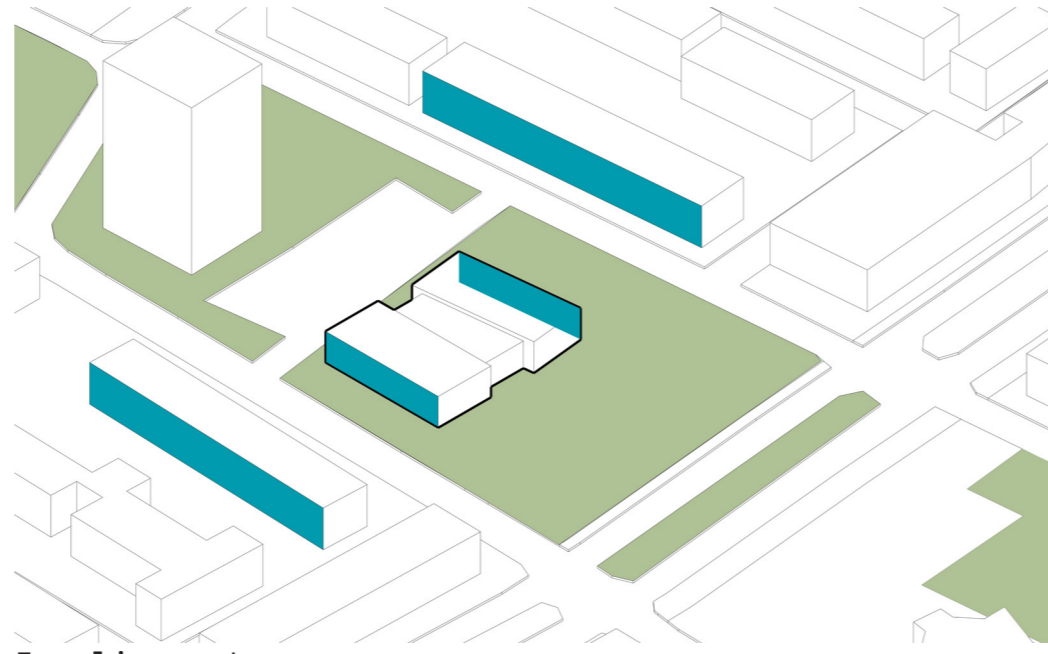
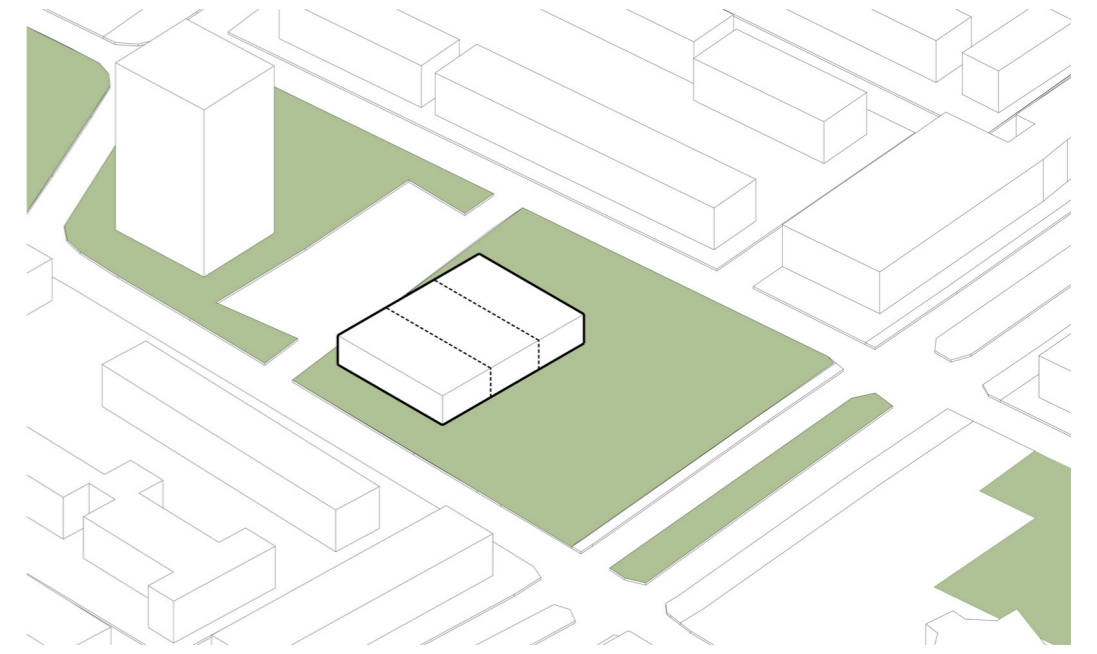
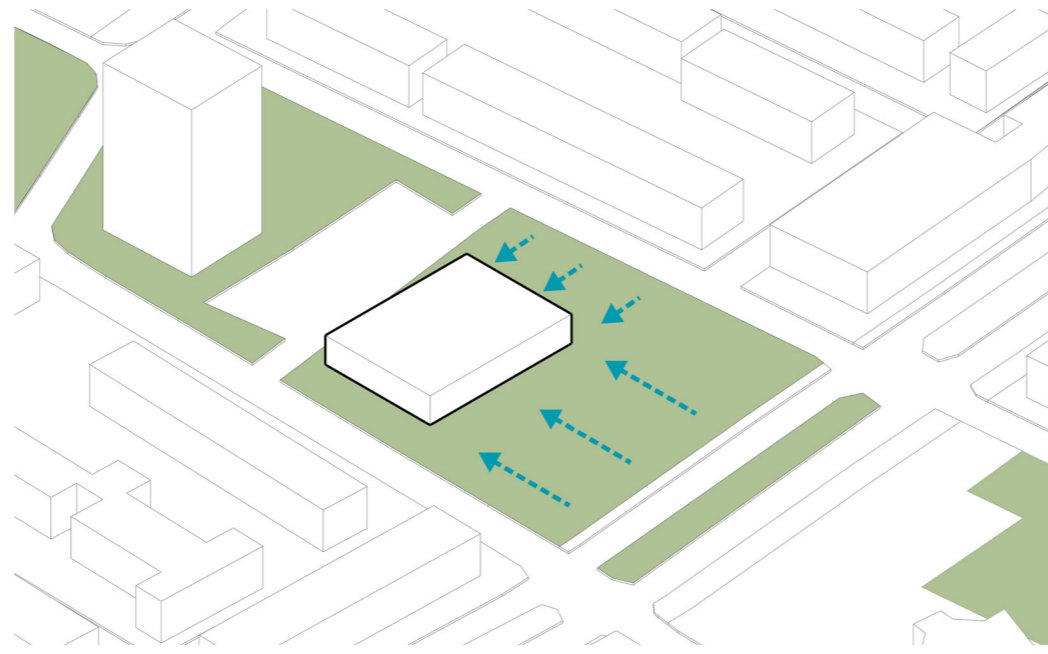
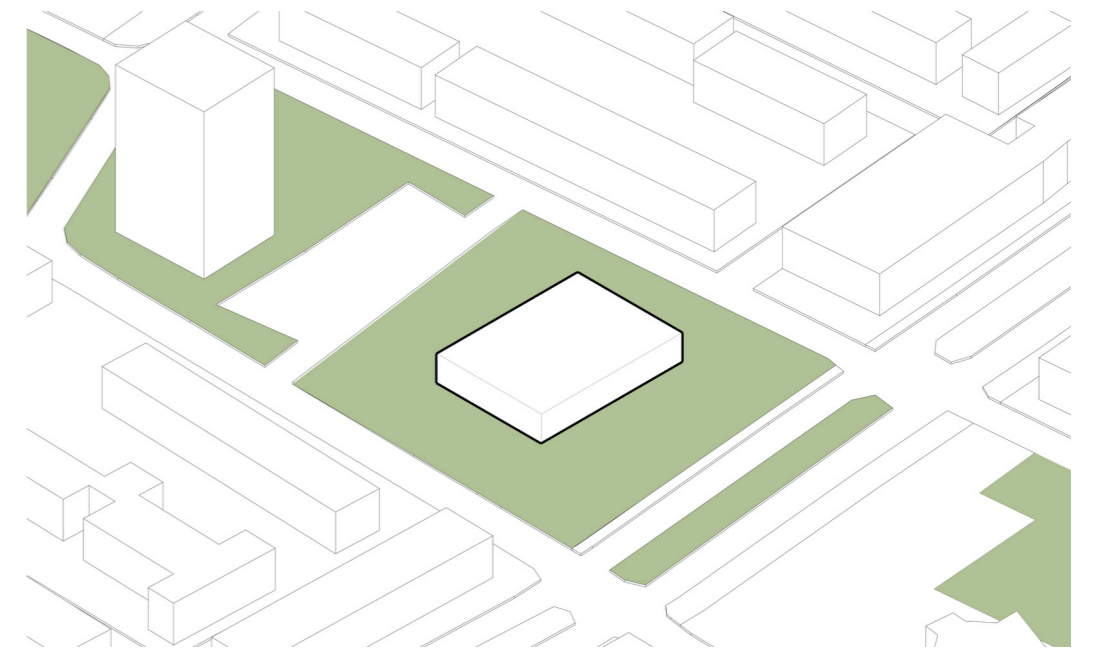
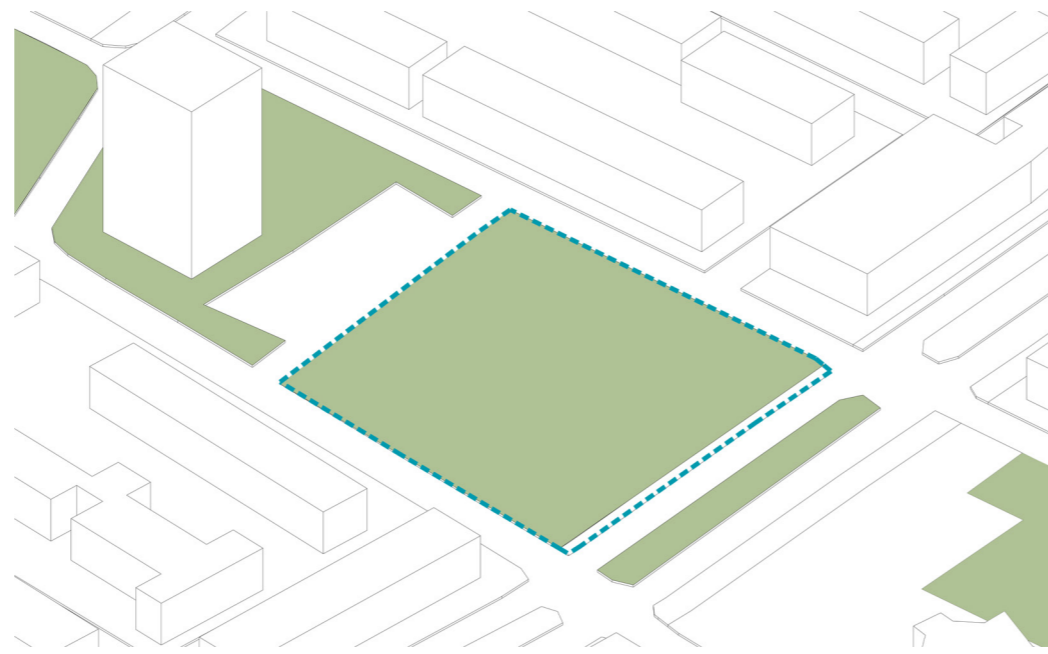

# Building

Neighbourhood to site

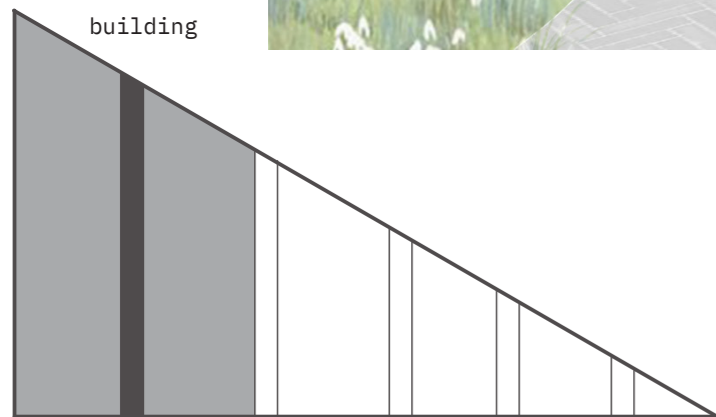

neighbourhood site

# Footpaths

STREET TO SCHOOLYARD

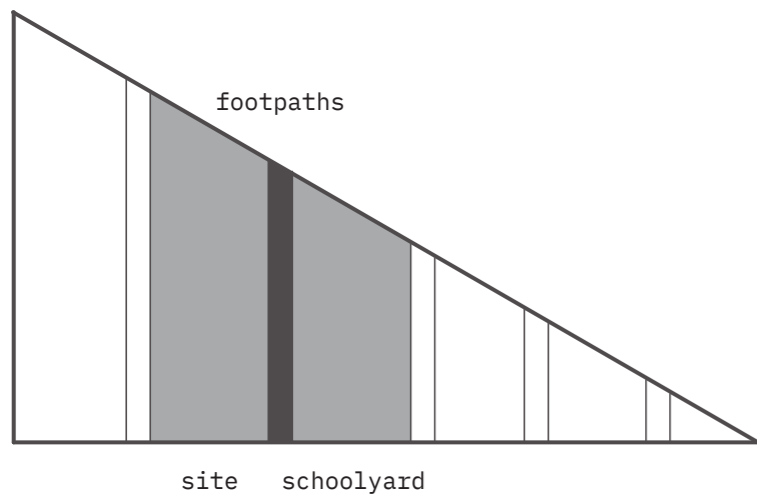

# Schoolyard

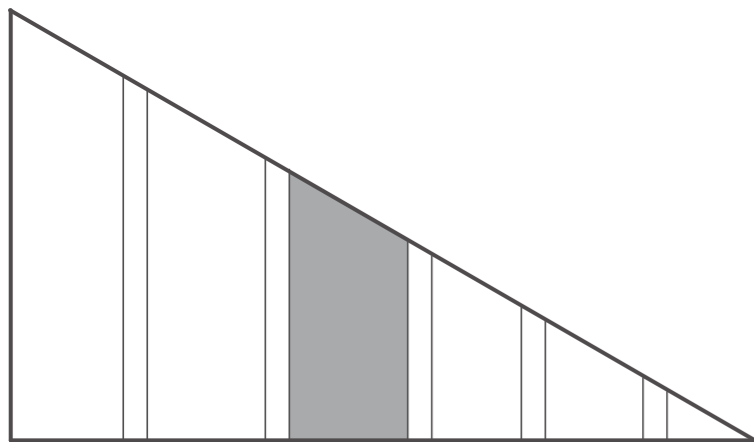

schoolyard

# Schoolyard

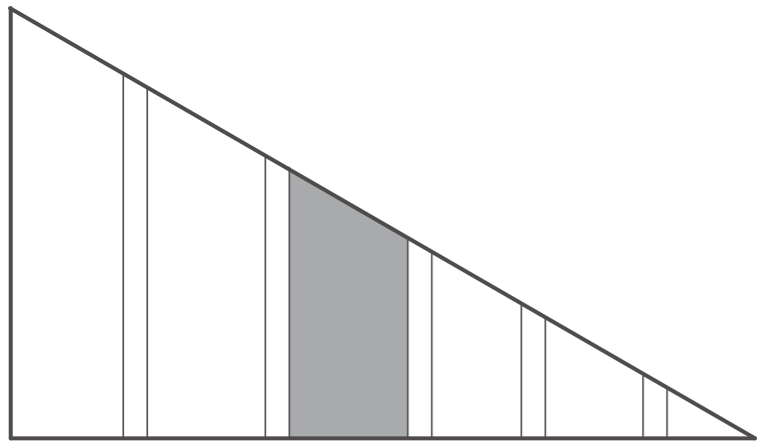

schoolyard

# School Entrance

SCHOOLYARD TO SCHOOL

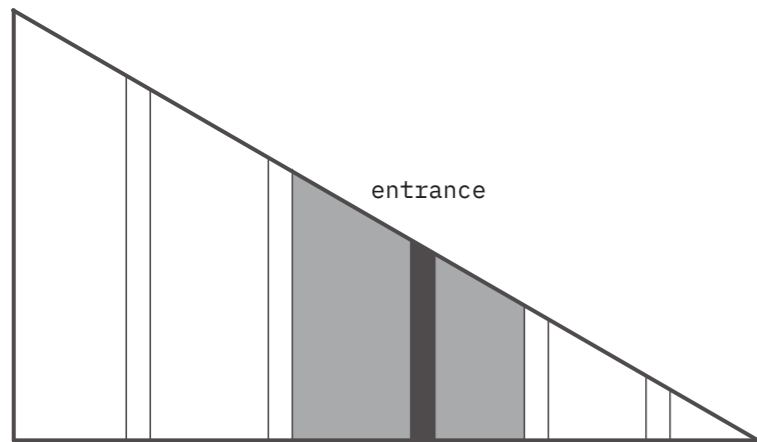

schoolyard school



# Plans

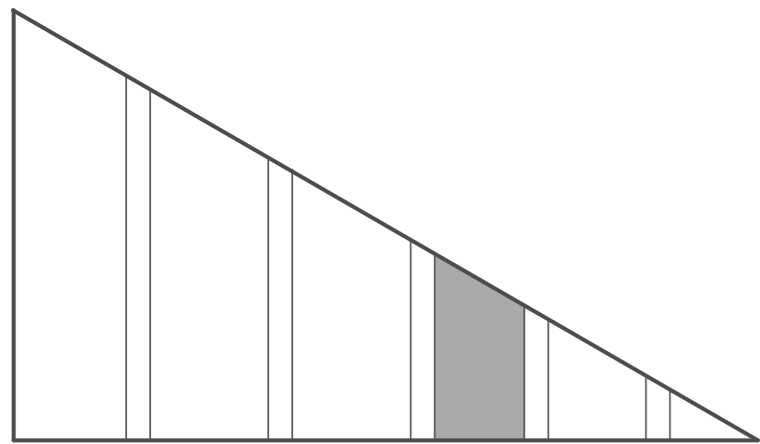
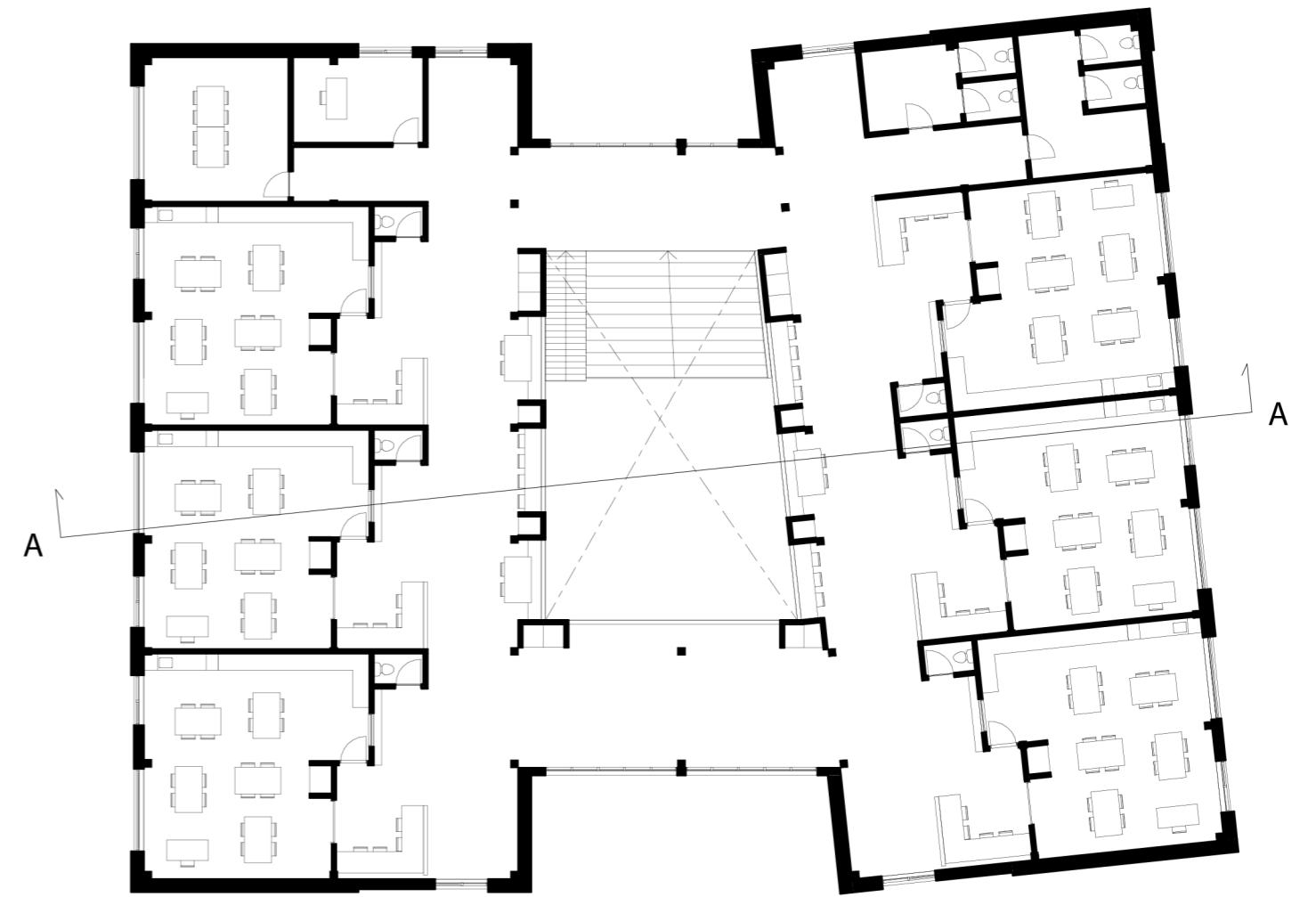
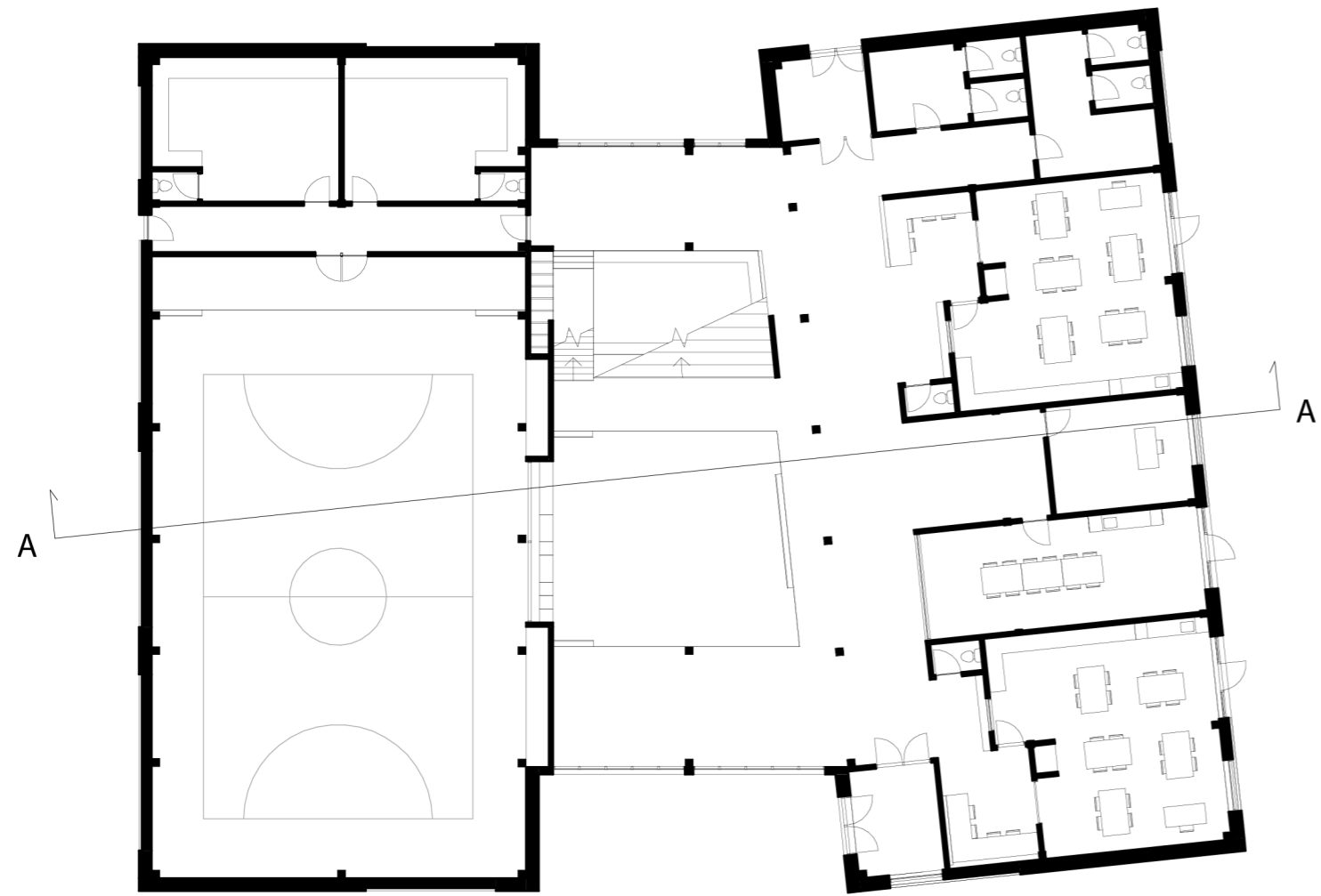

school

# Section

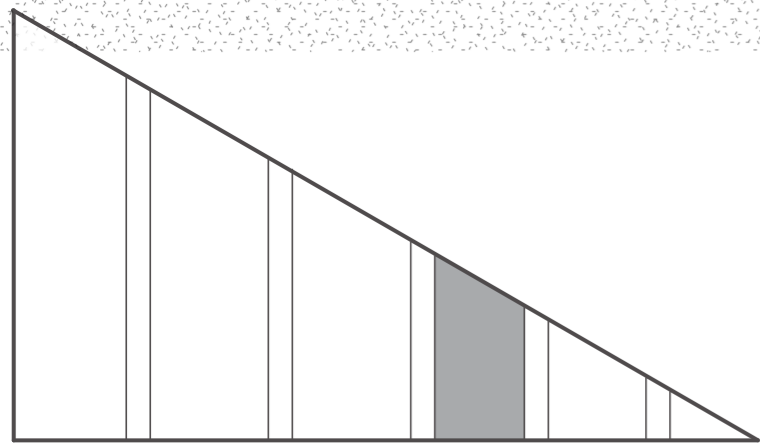

school

# Structural Principle

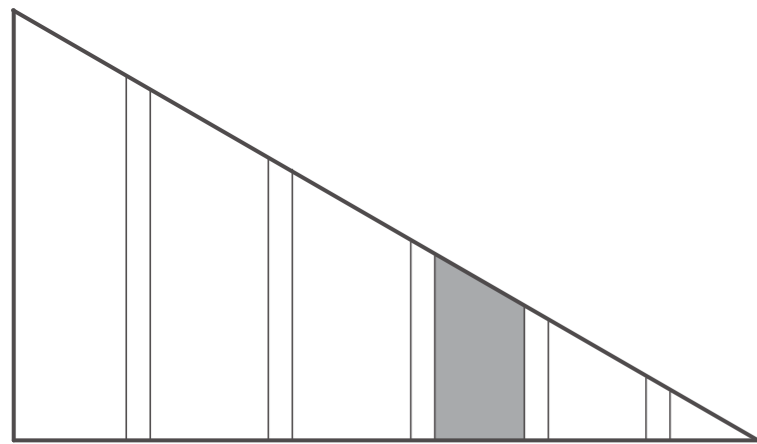
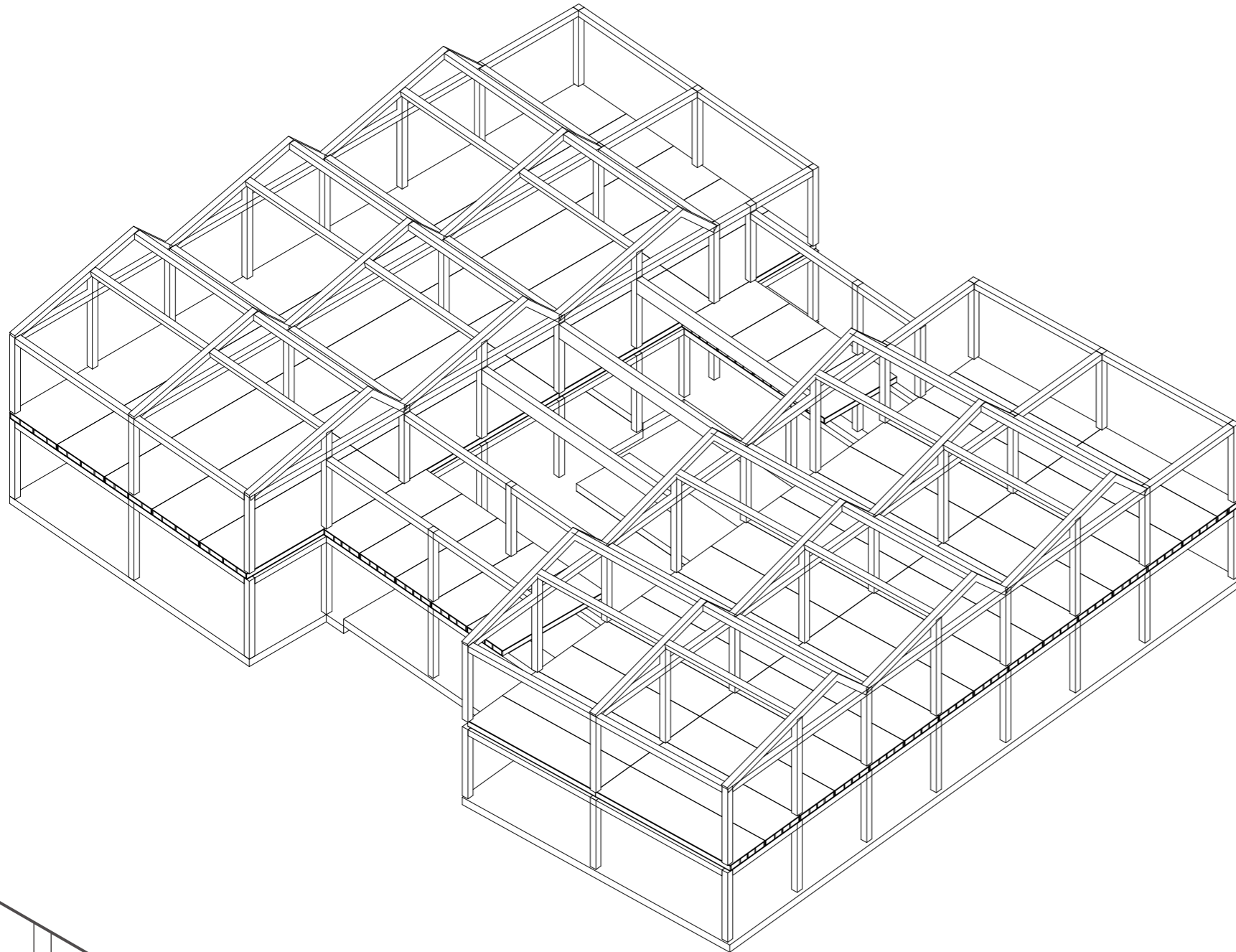

school

1. concrete floor
2. glulam column
3. glulam beam
4. wooden hollow core slab
5. selfsupporting roof with tiles

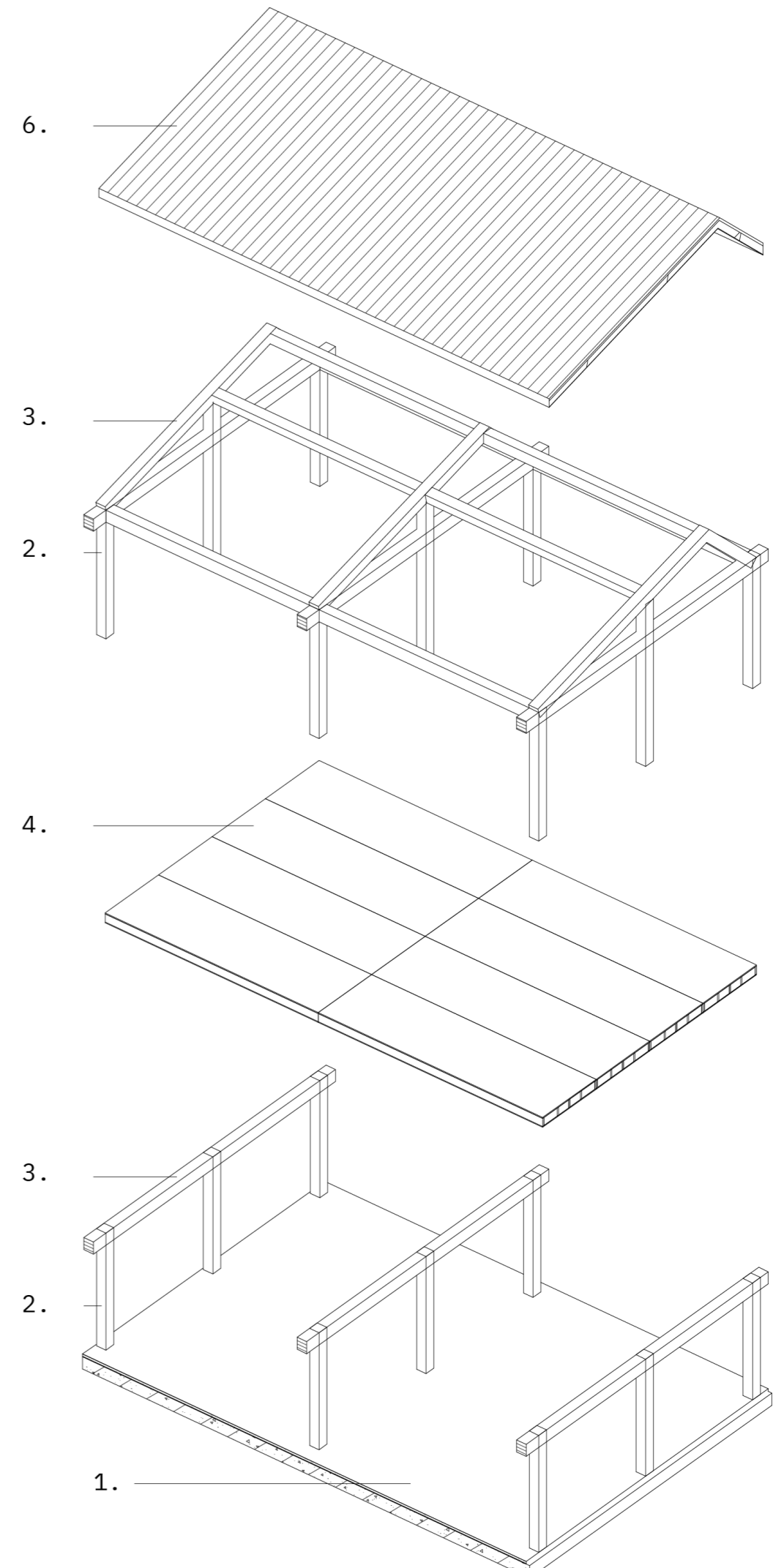

# Facade Fragment

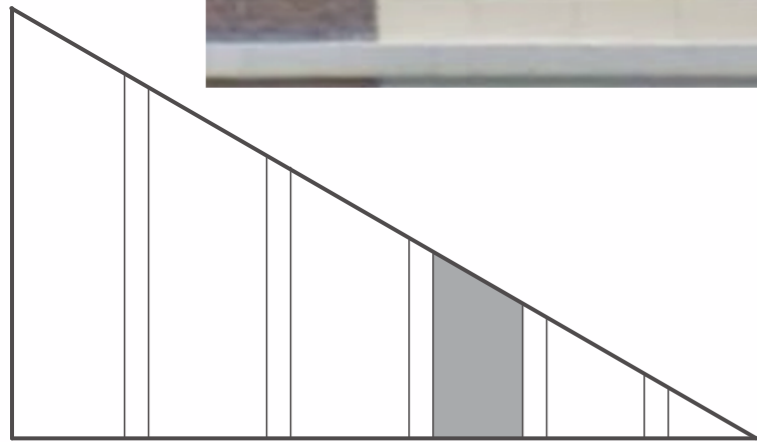

school

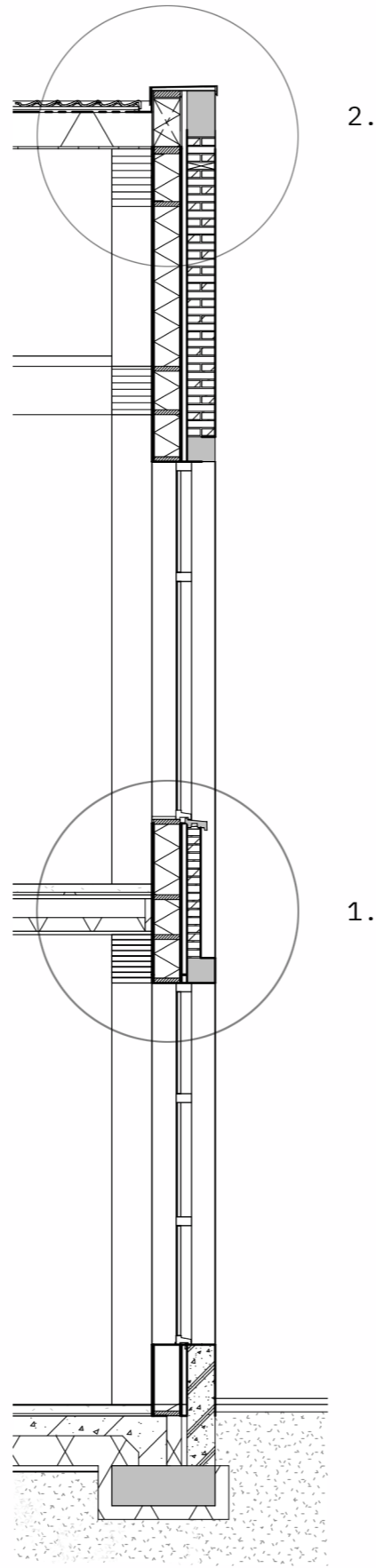

2.

1.

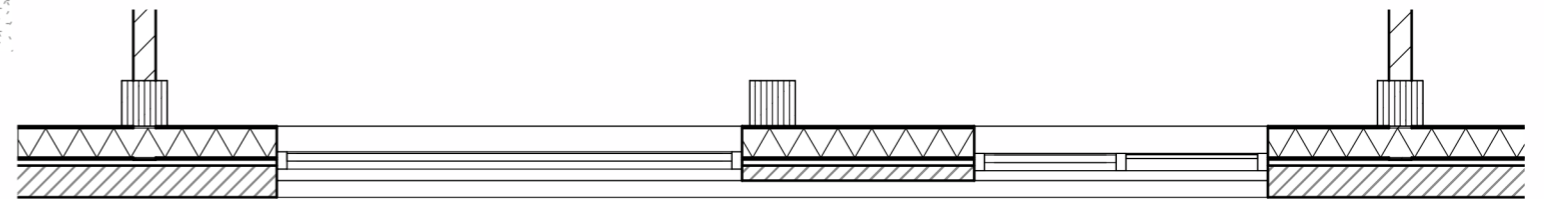

# Detailing

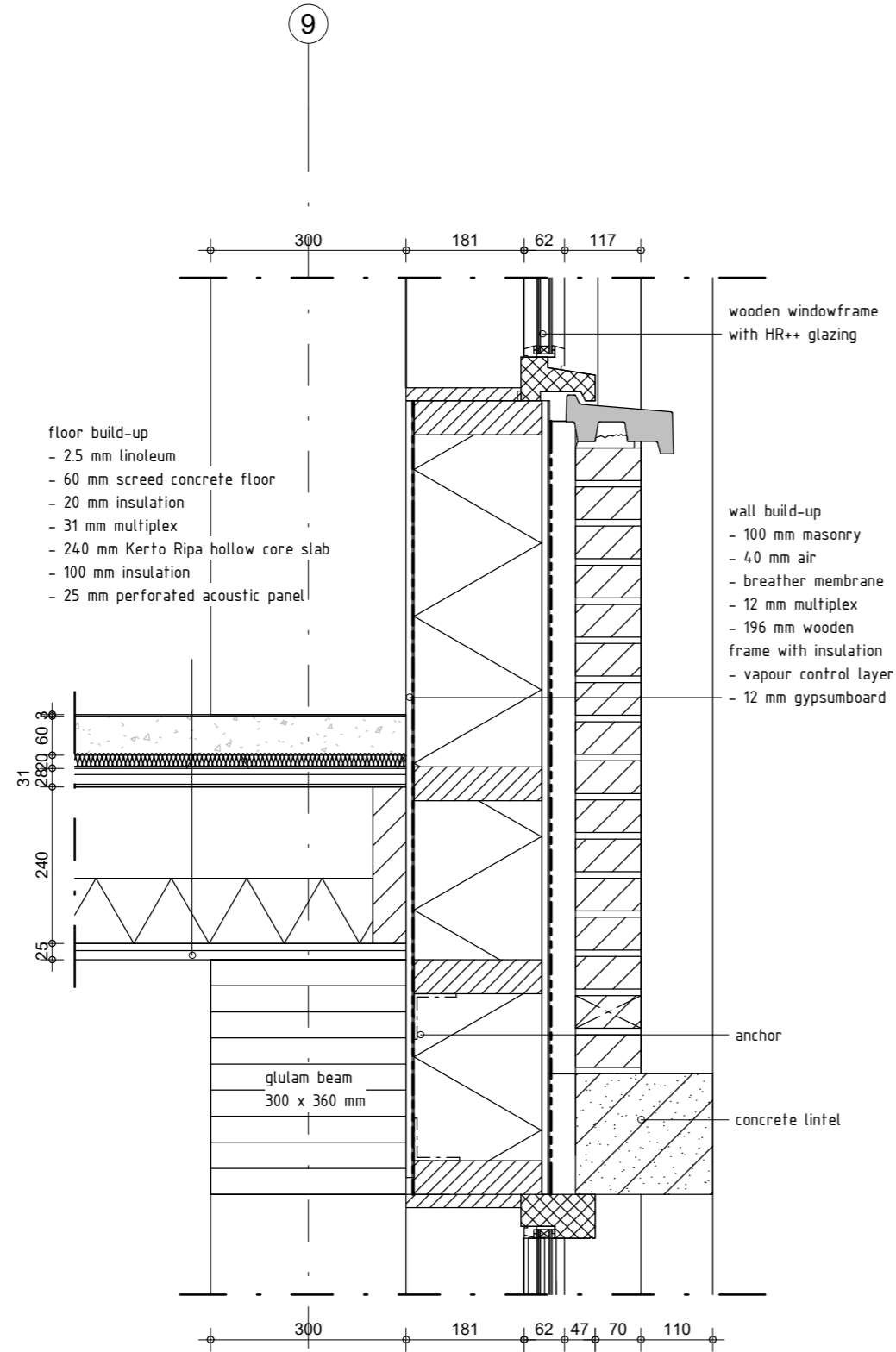

1.

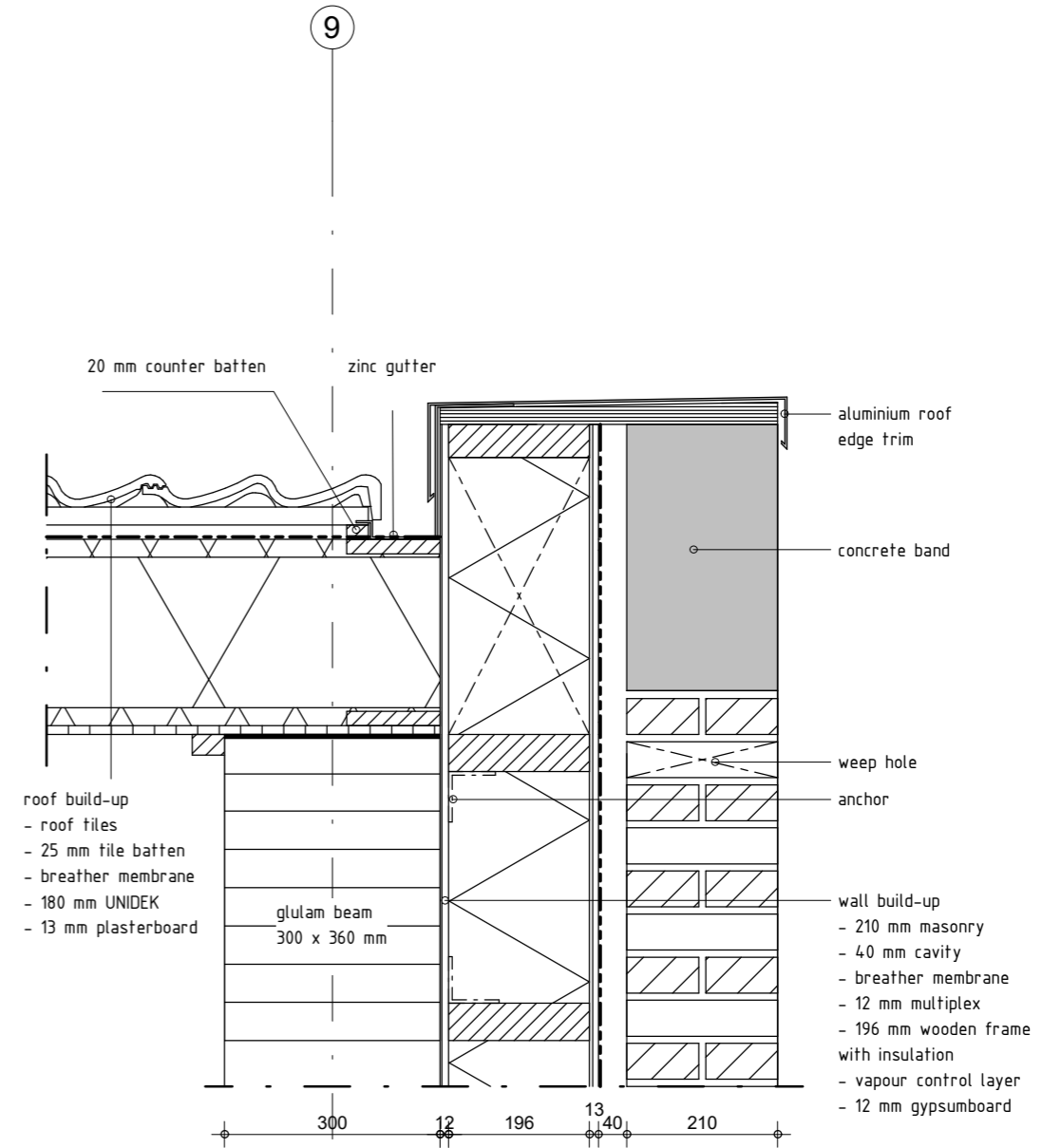

2.

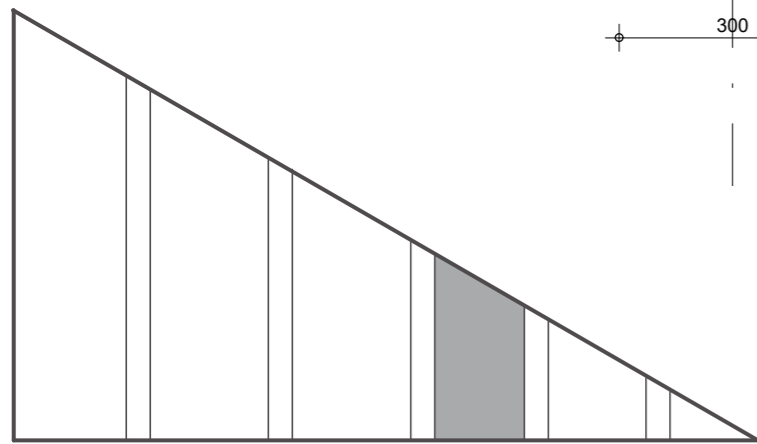

school

# Multifunctional Wall

SCHOOL TO ATRIUM

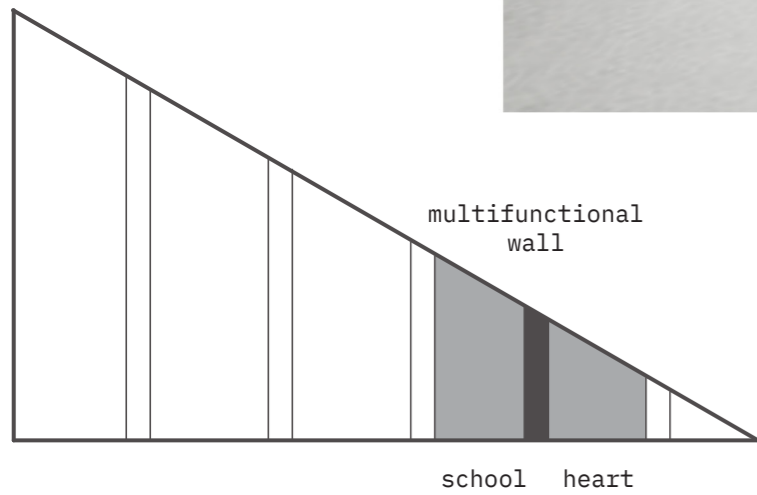

# Multifunctional Wall

SCHOOL TO ATRIUM

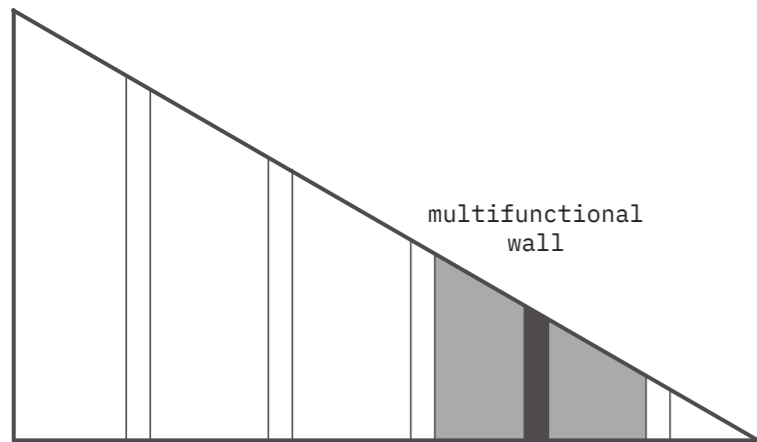

multifunctional wall

school heart

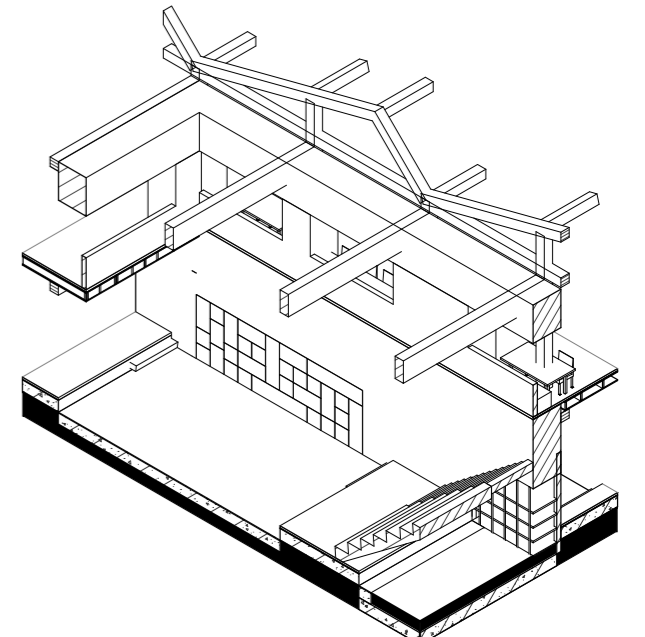

1. blocks stored in wall

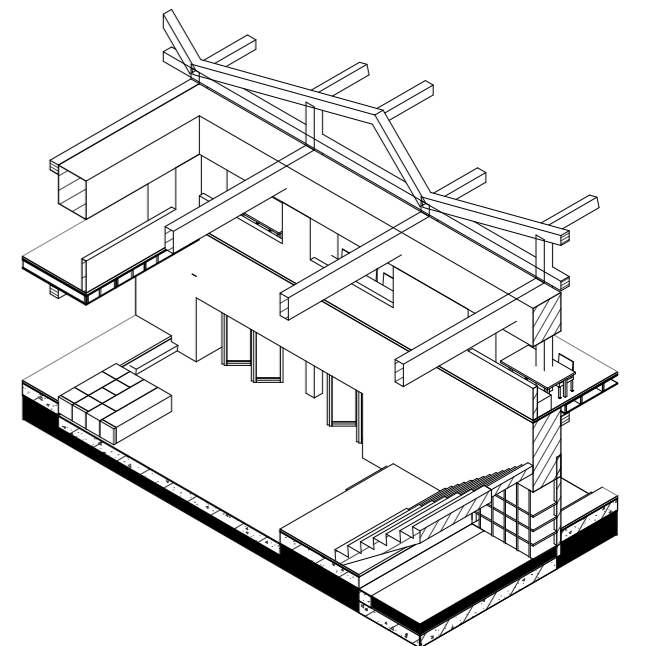

3. stage for performance

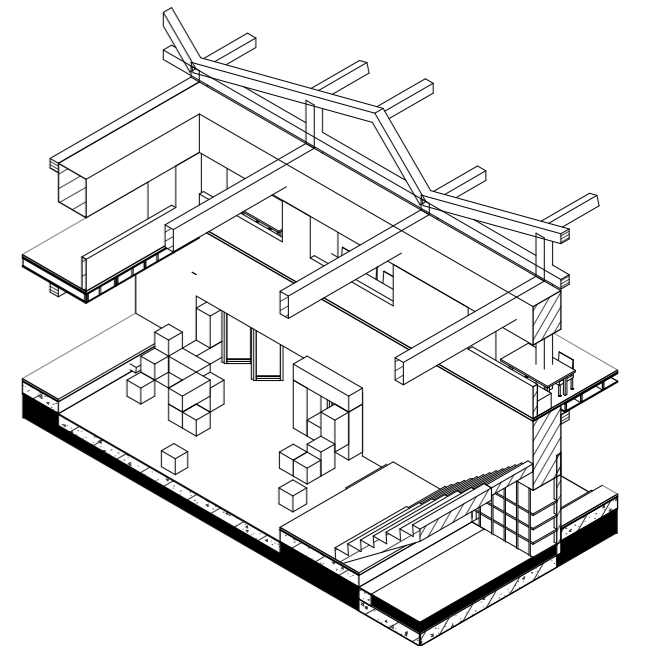

4. fortresses (or similair)

2. sitting spots during lunch

# Corridor

ATRIUM TO CLASSROOM

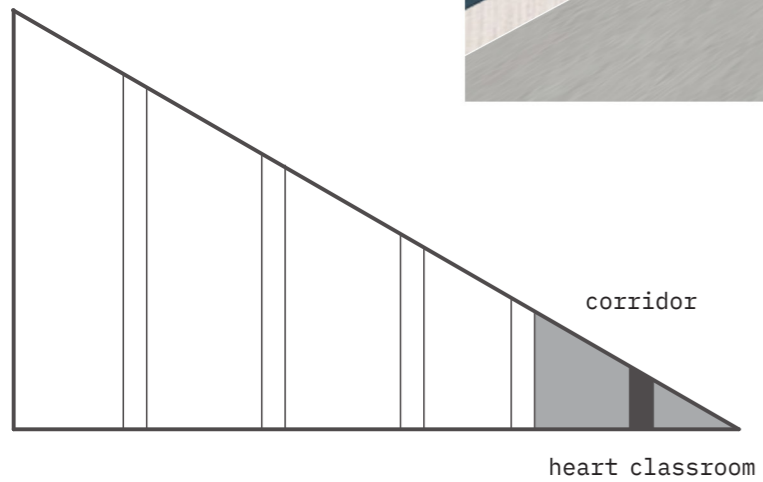



# Threshold space

ATRIUM TO CLASSROOM

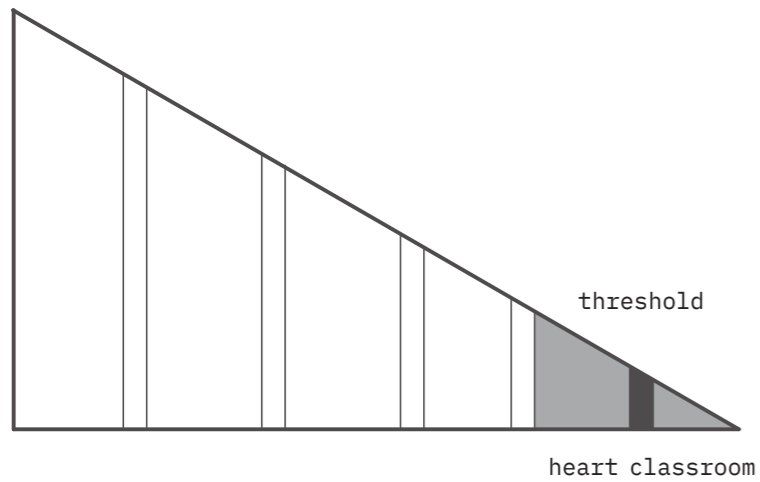

# Classroom

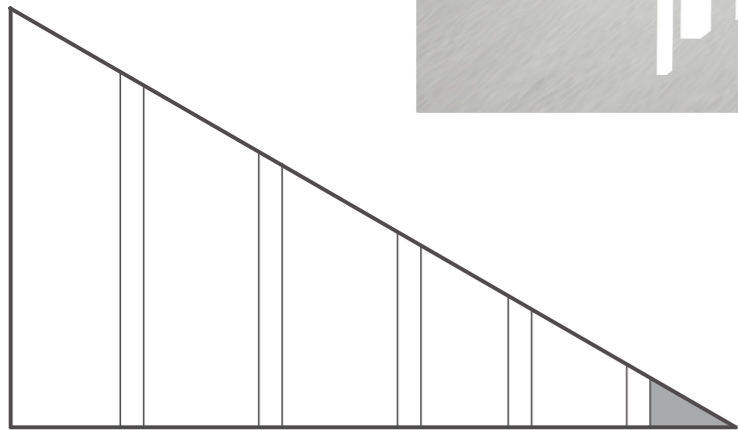

classroom