

# ELEMENTAIR ONTWERPEN

## 1 | ZWEMBADHUIS

1:200

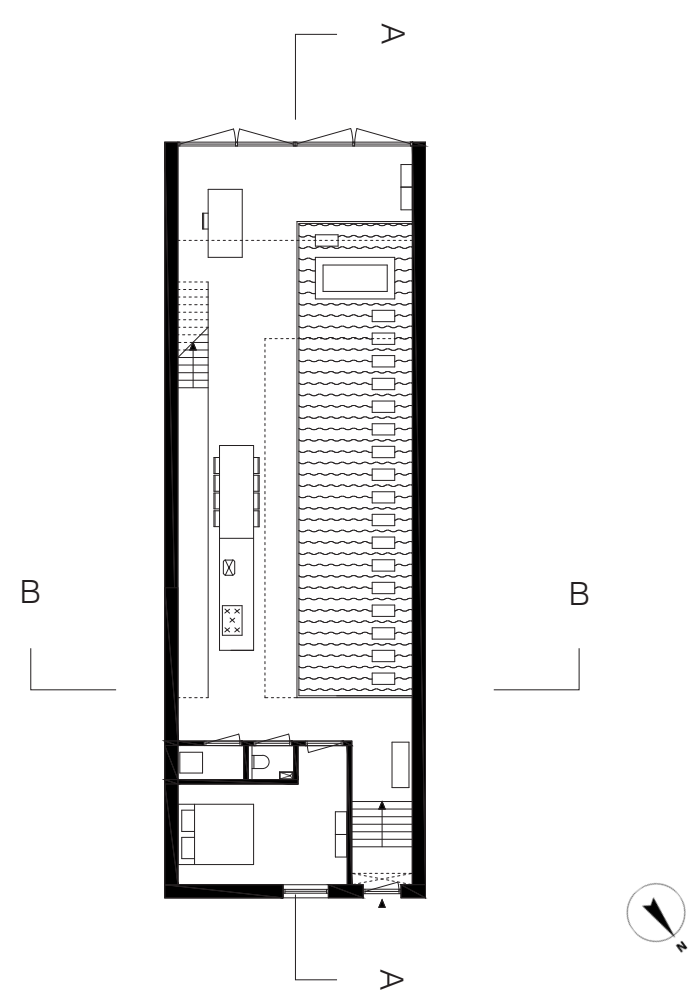

Begane grond

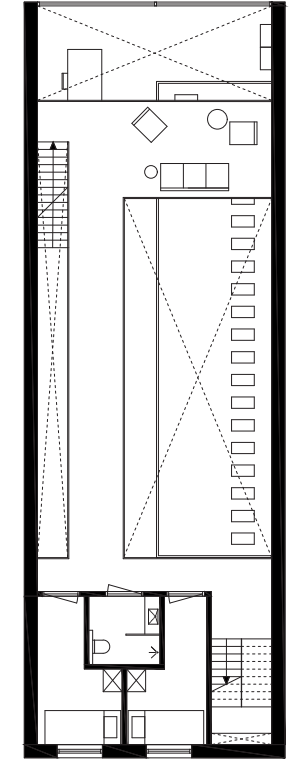

Eerste verdieping

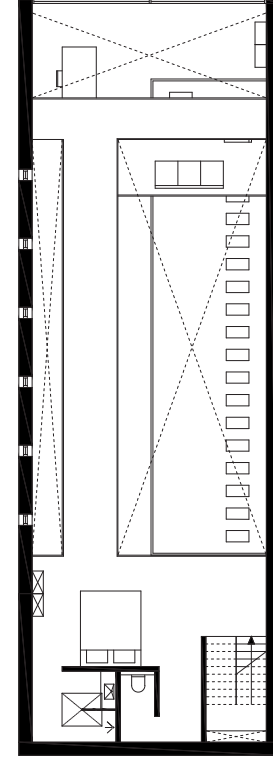

Tweede verdieping

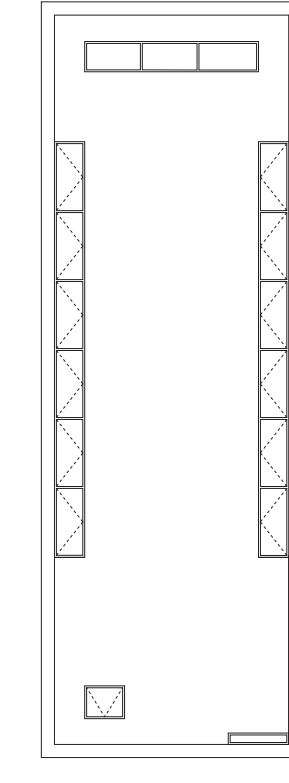

Dakaanzicht

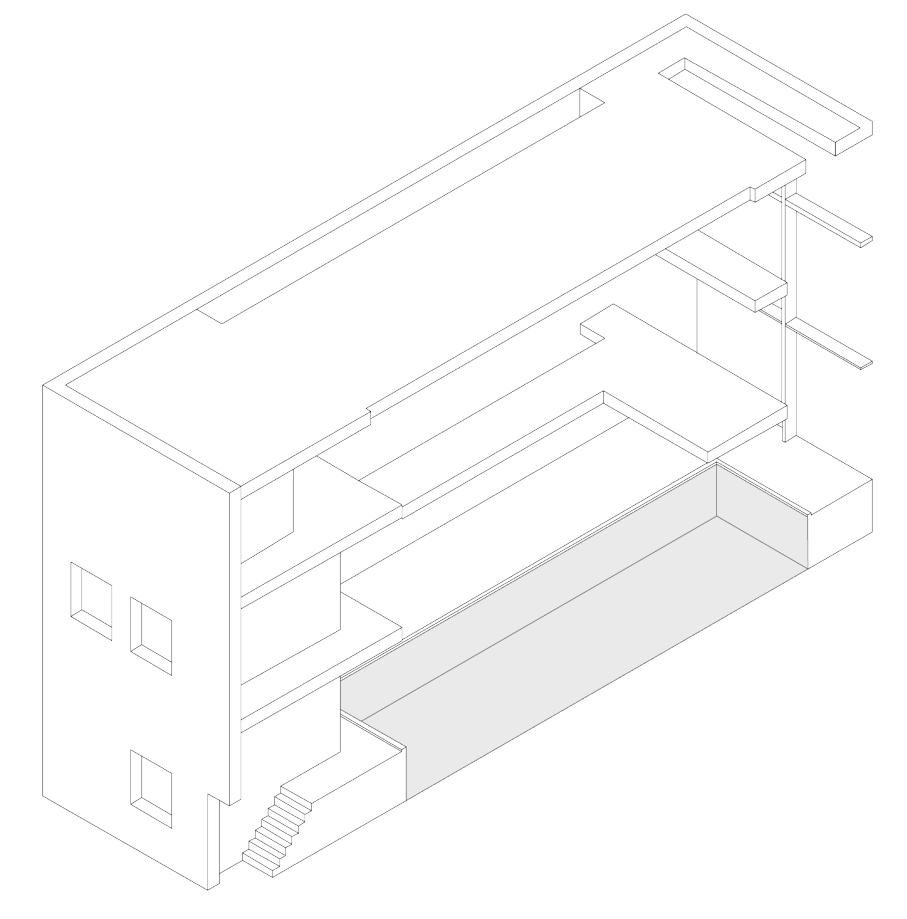

3D

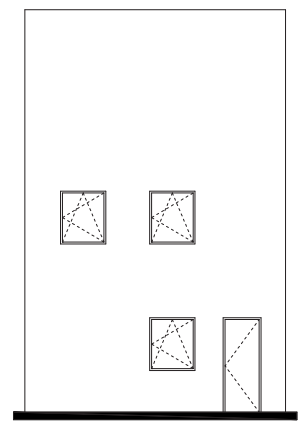

Gevel noord

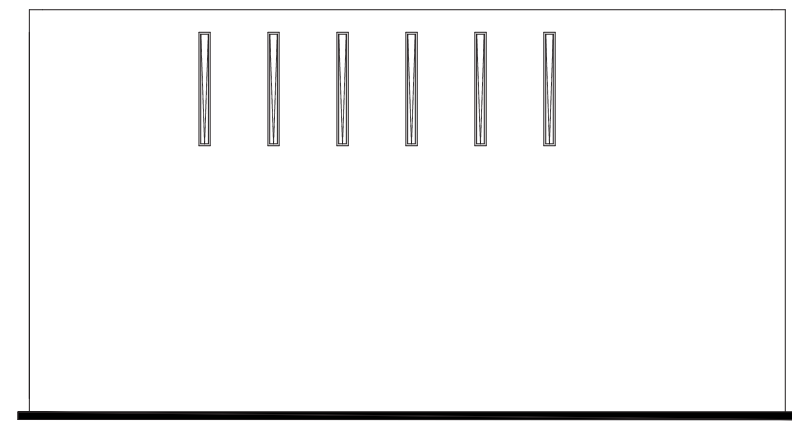

Gevel oost

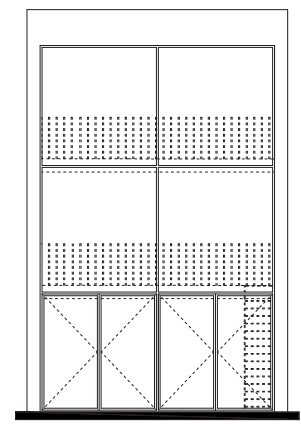

Gevel zuid

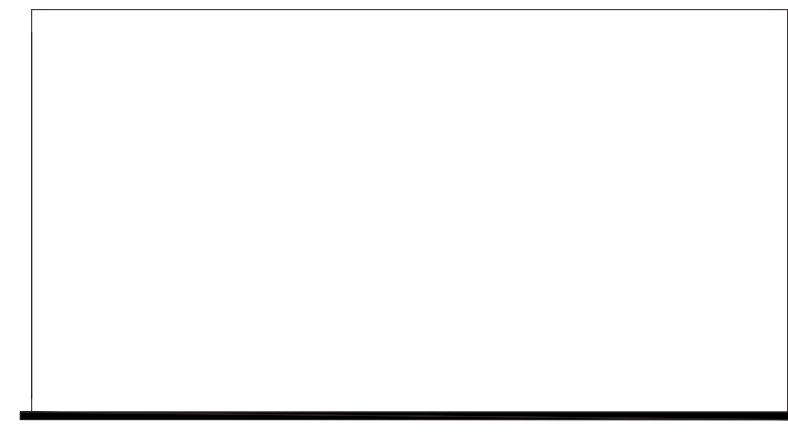

Gevel west

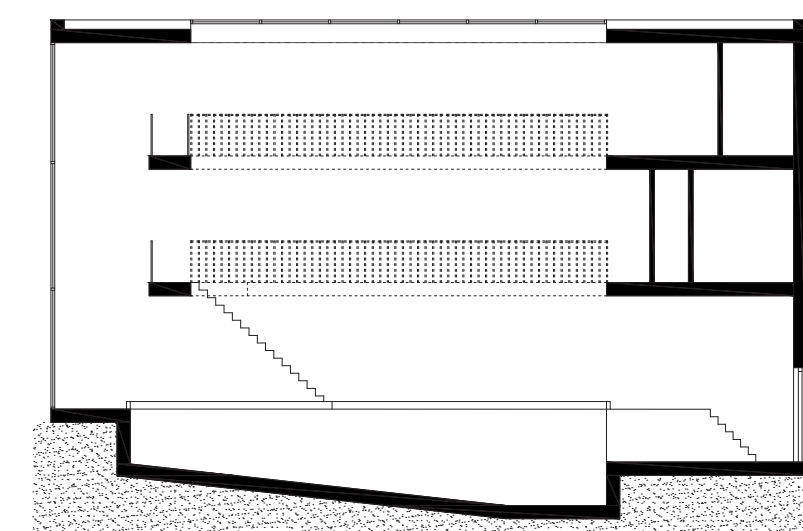

Doorsnede A

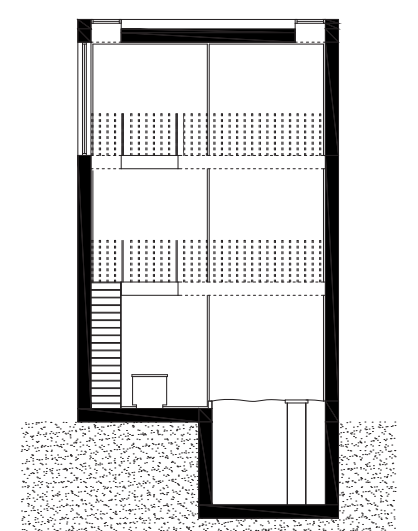

Doorsnede B

## 2 | HUIS ZONDER GANG

1:200

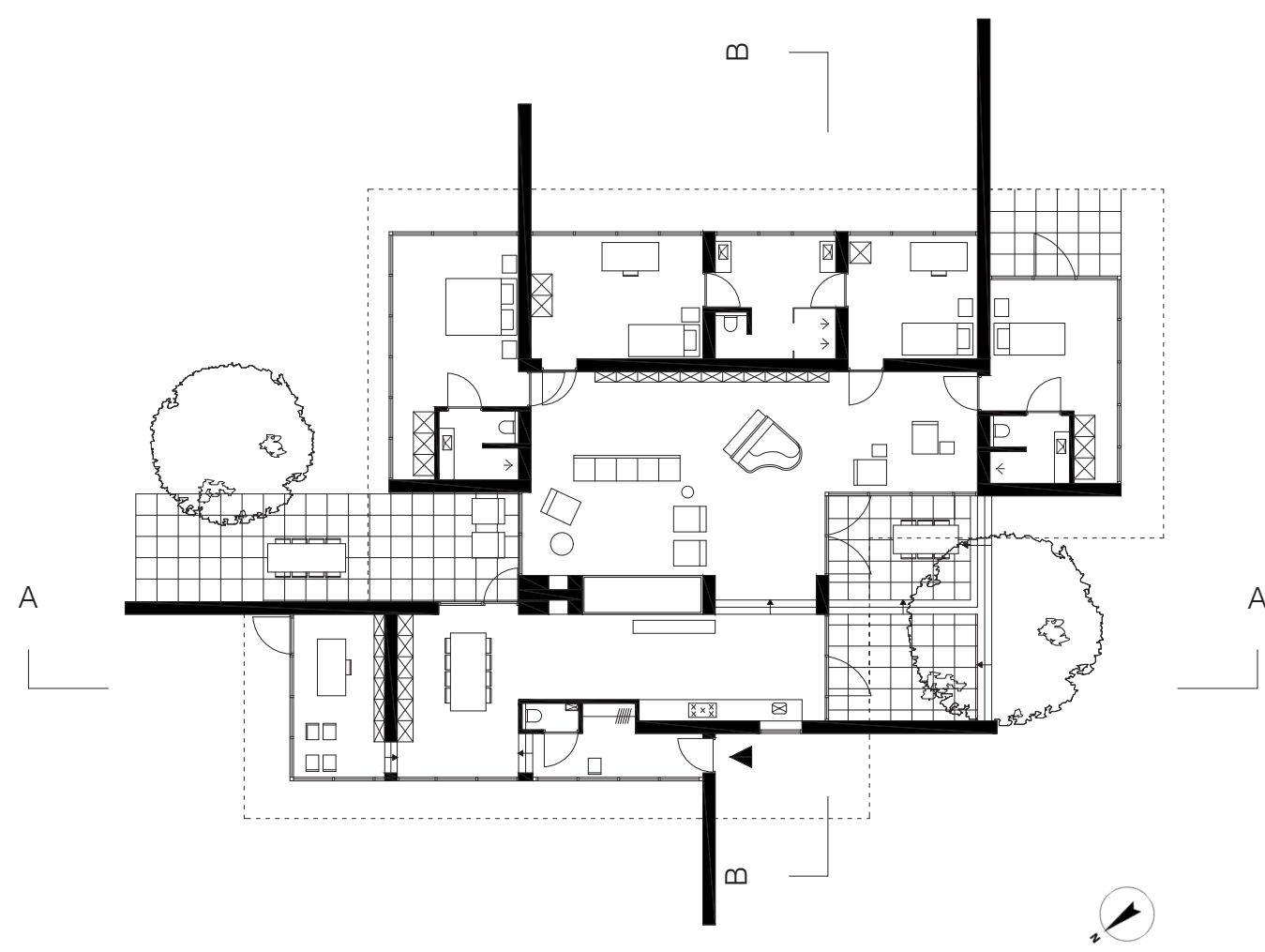

Plattegrond

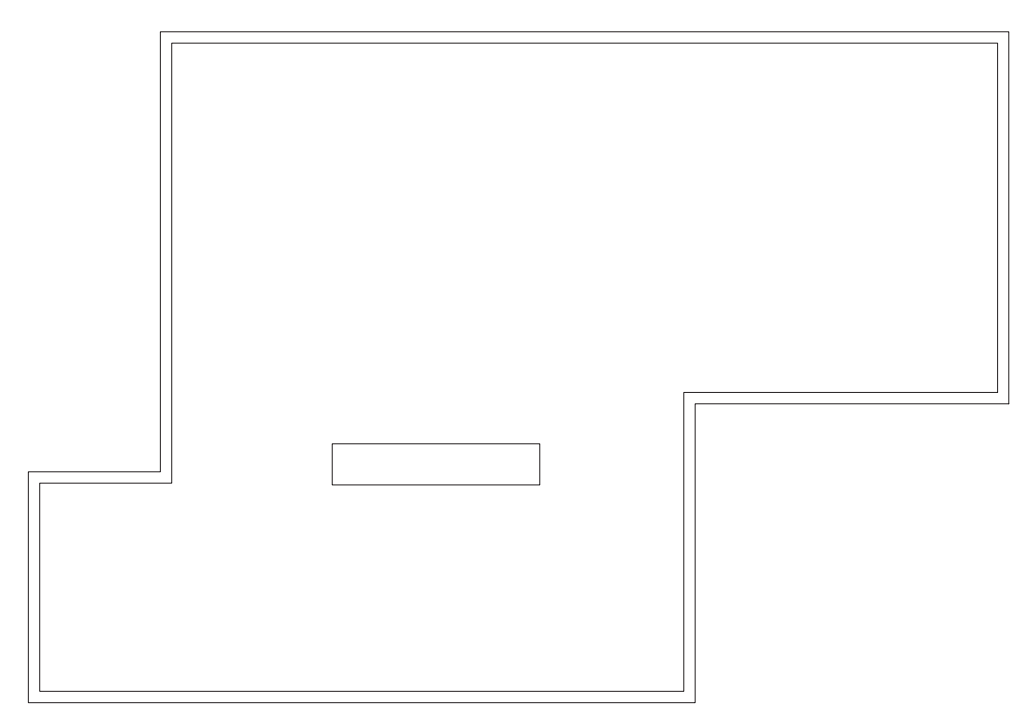

Dakaanzicht

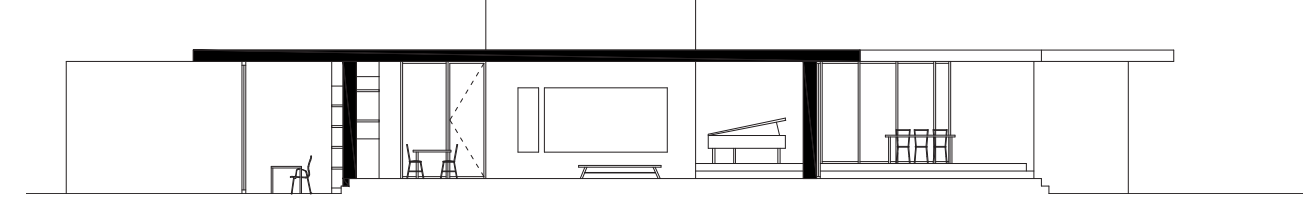

Doorsnede A

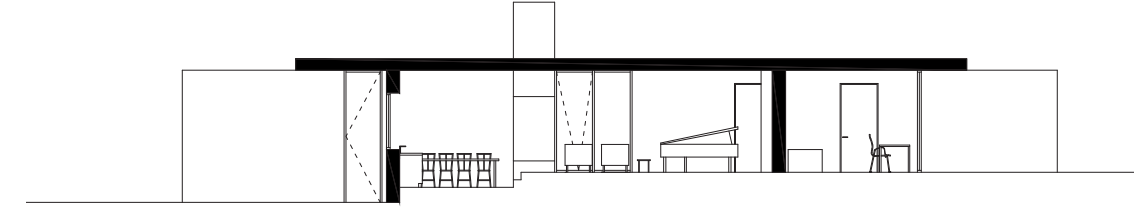

Doorsnede B

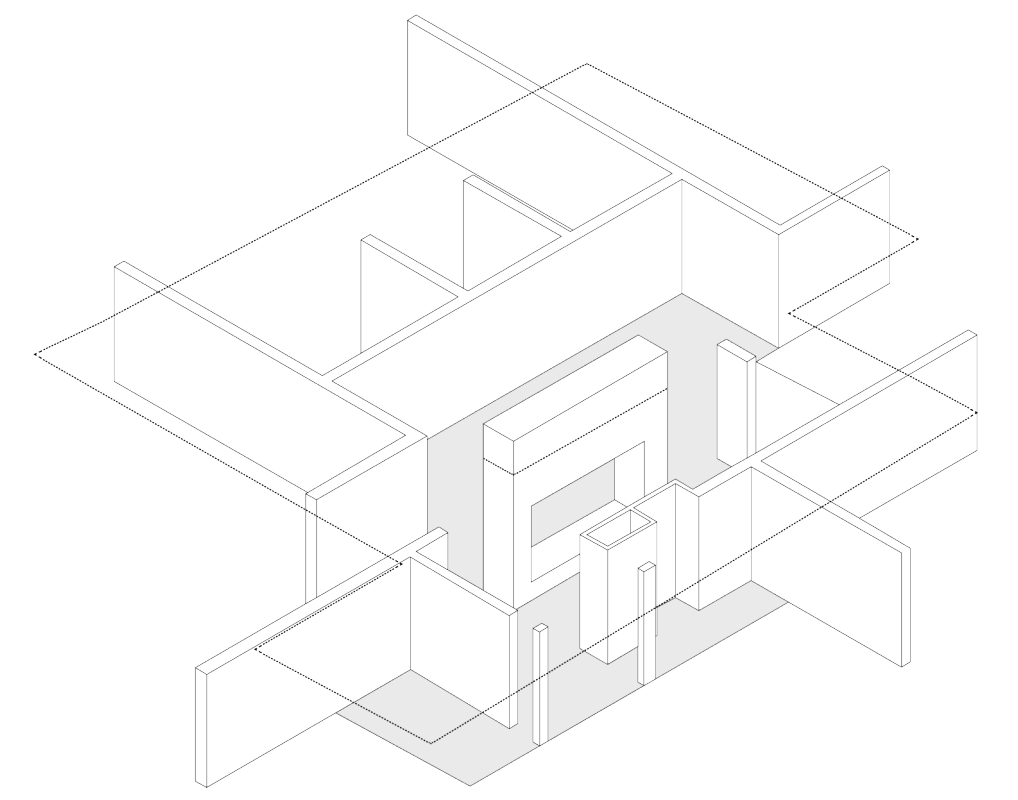

3D

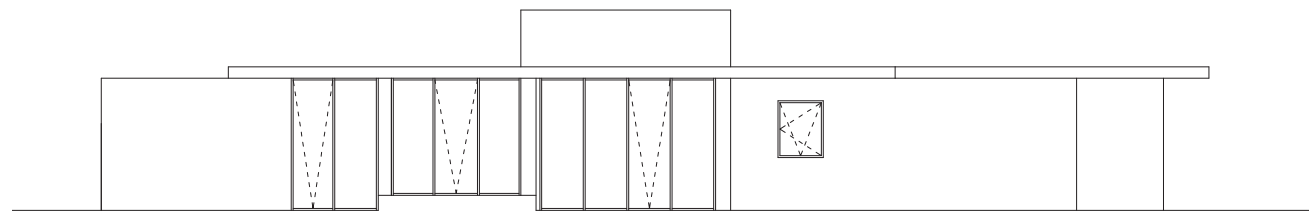

Gevel noord

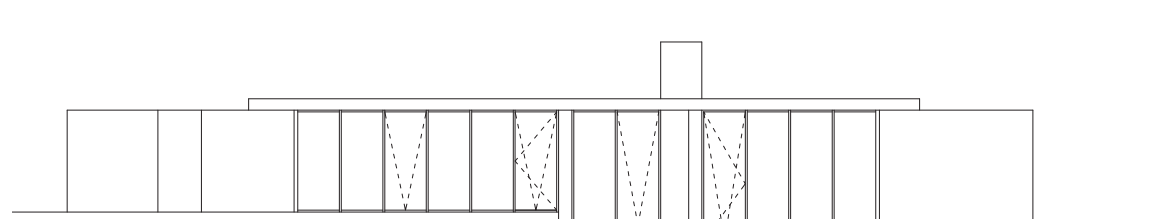

Gevel oost

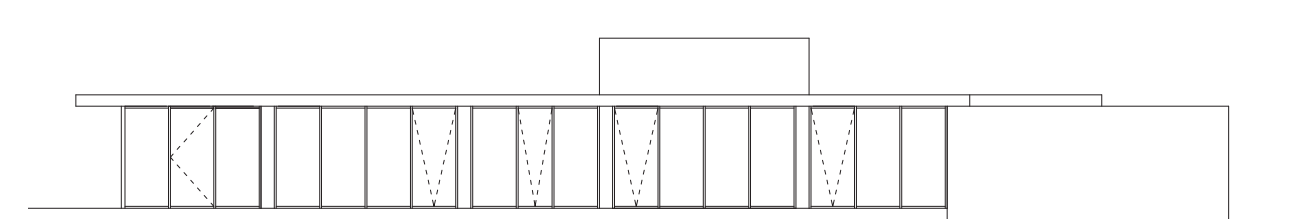

Gevel zuid

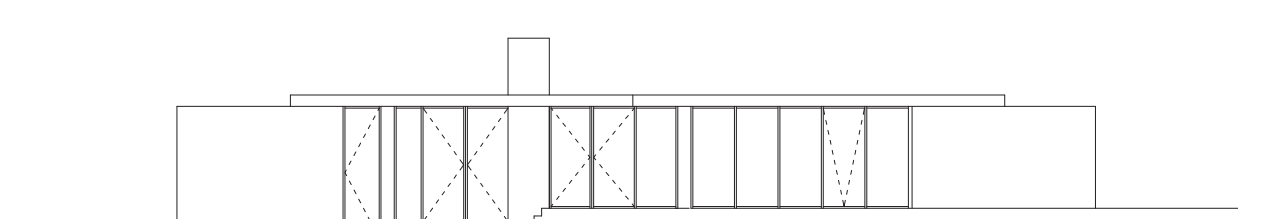

Gevel west

## 3 | 10 X 10 X 10

1:200

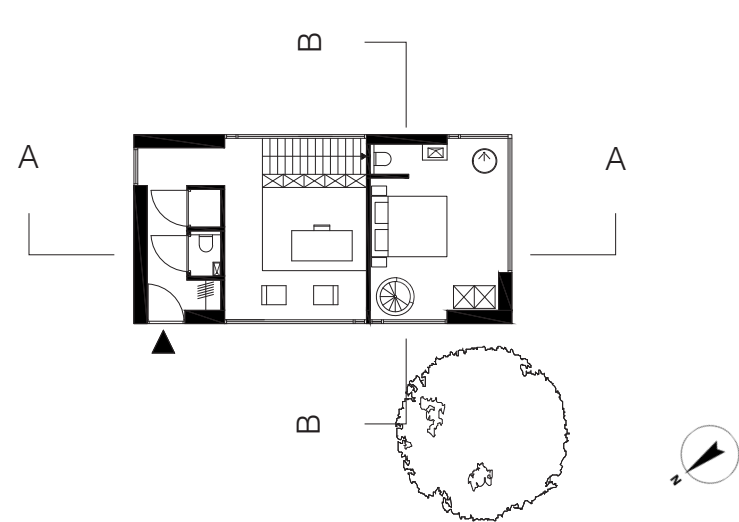

Begane grond

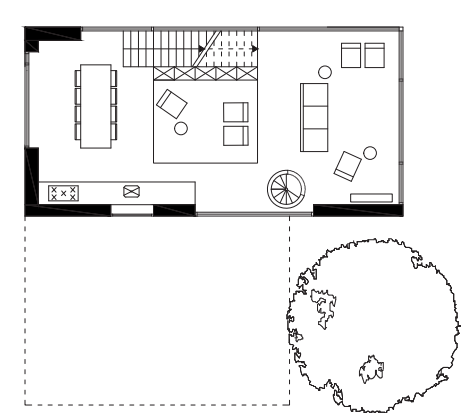

Eerste verdieping

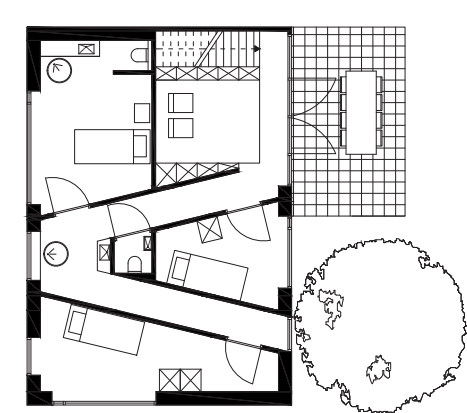

Tweede verdieping

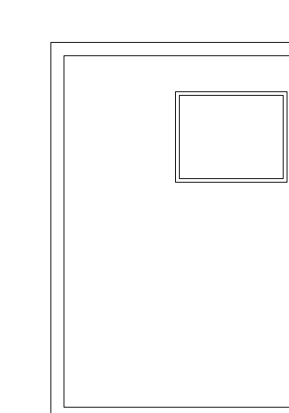

Dakaanzicht

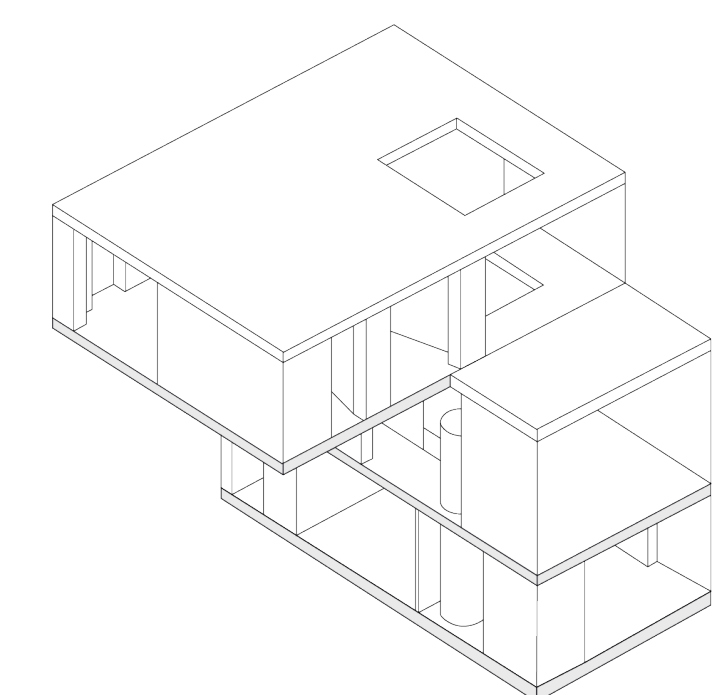

3D

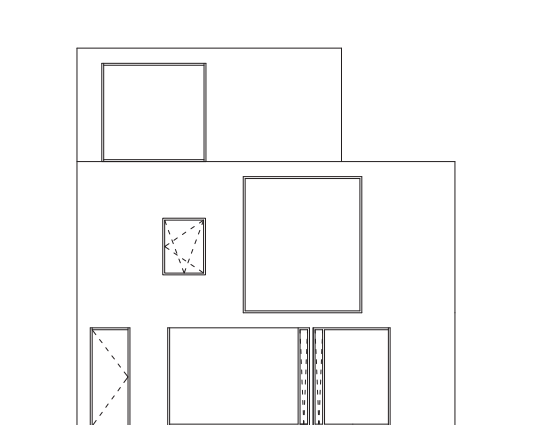

Gevel noord

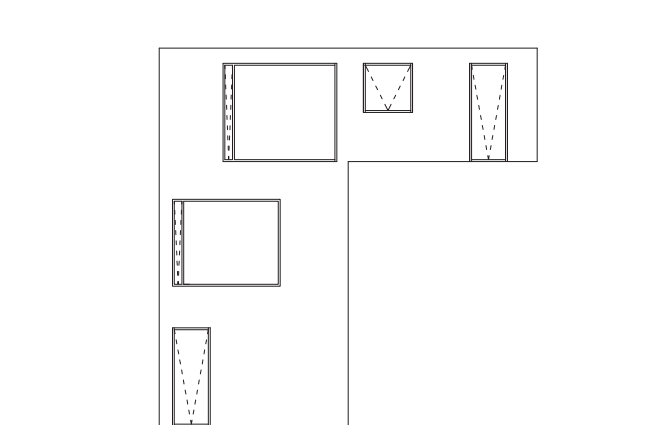

Gevel oost

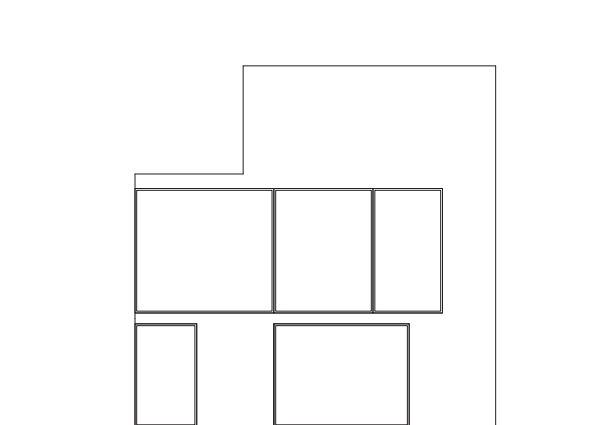

Gevel zuid

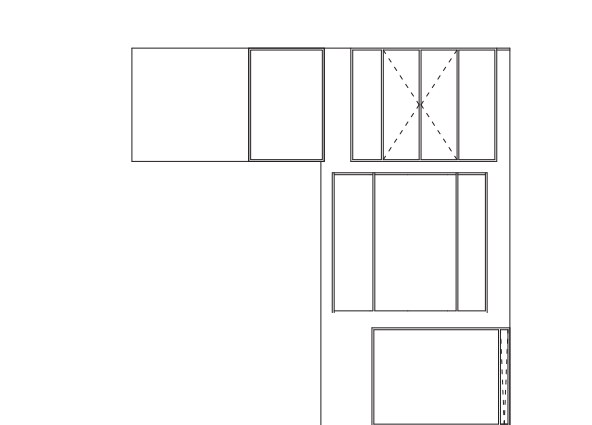

Gevel west

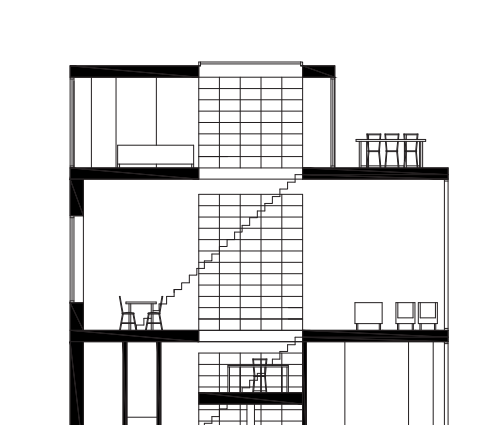

Doorsnede A

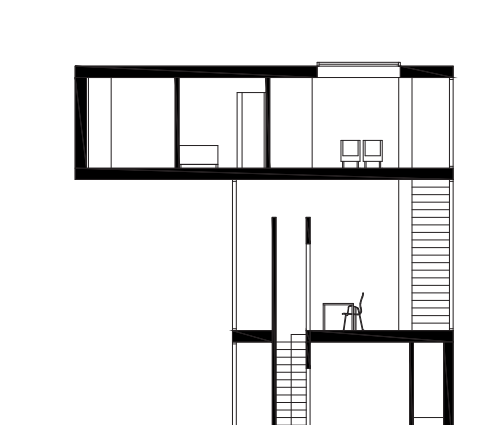

Doorsnede B

4 | BOEKENHUIS  
1:200

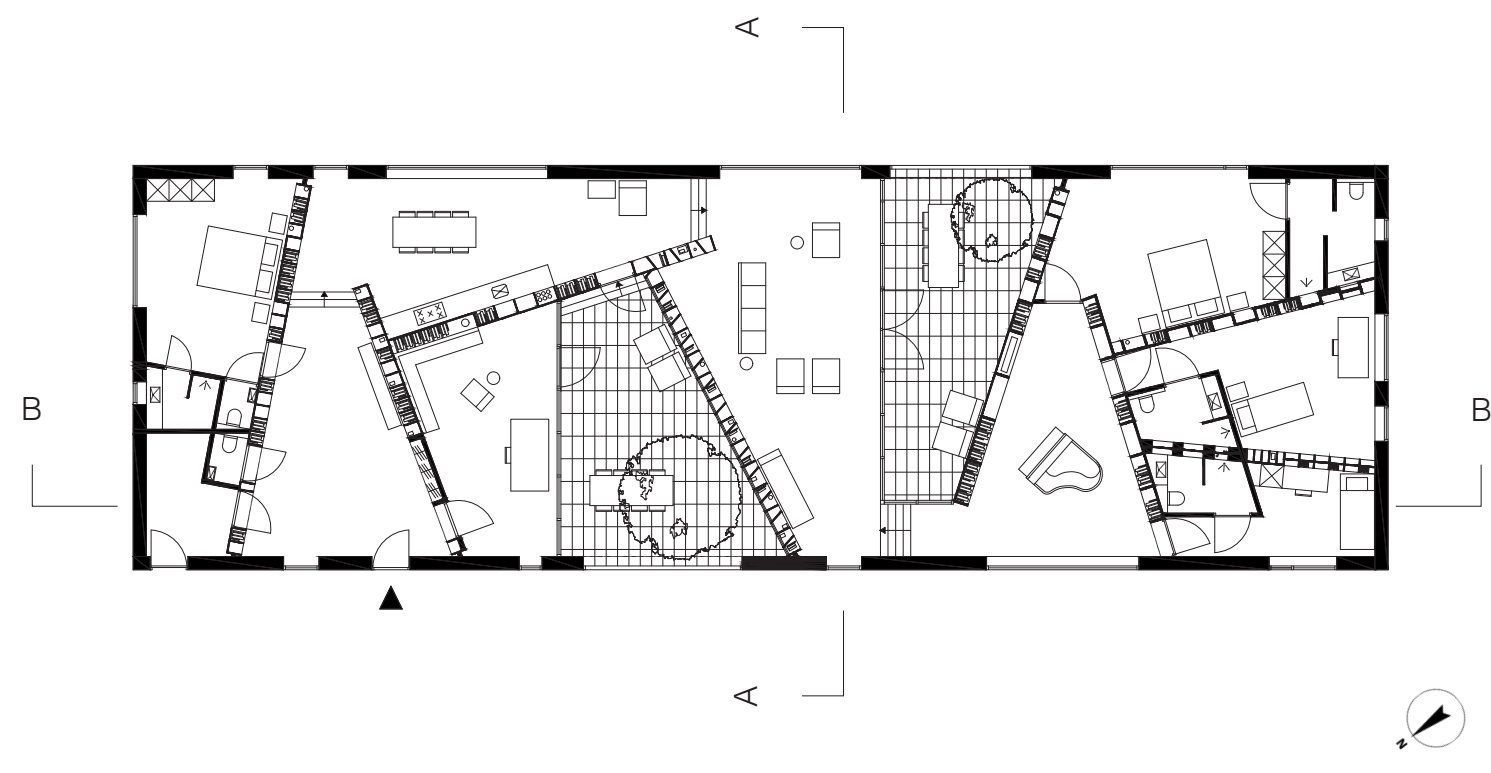

Begane grond

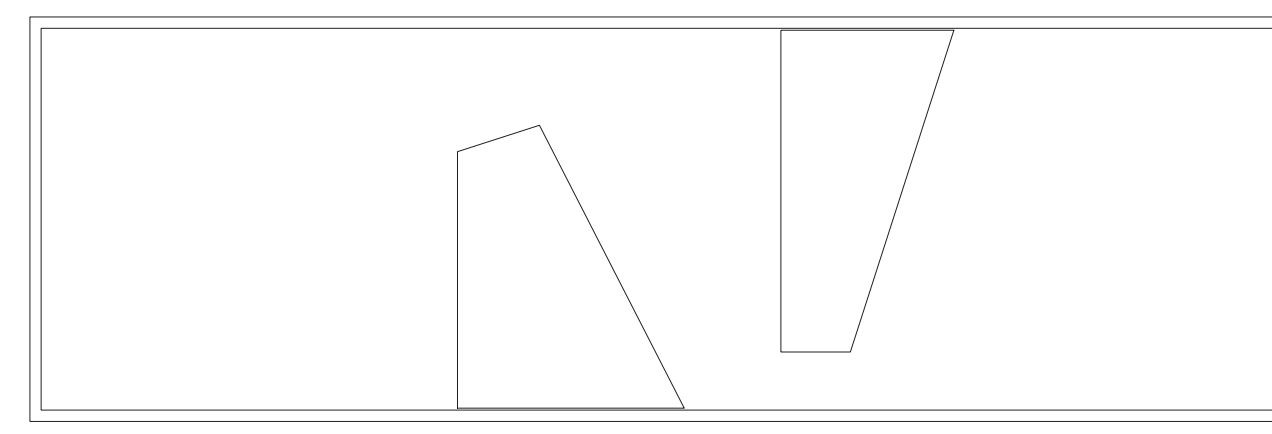

Dakaanzicht

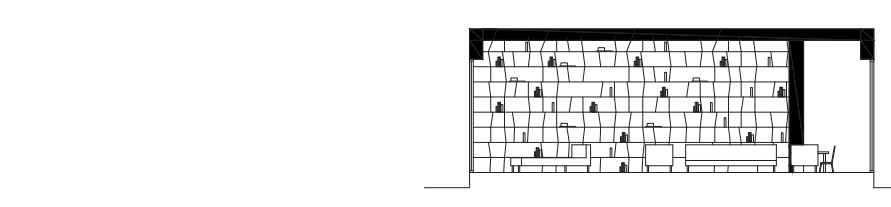

Doorsnede A

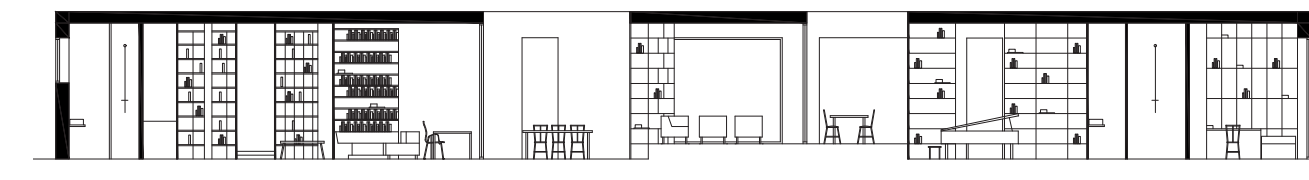

Doorsnede B

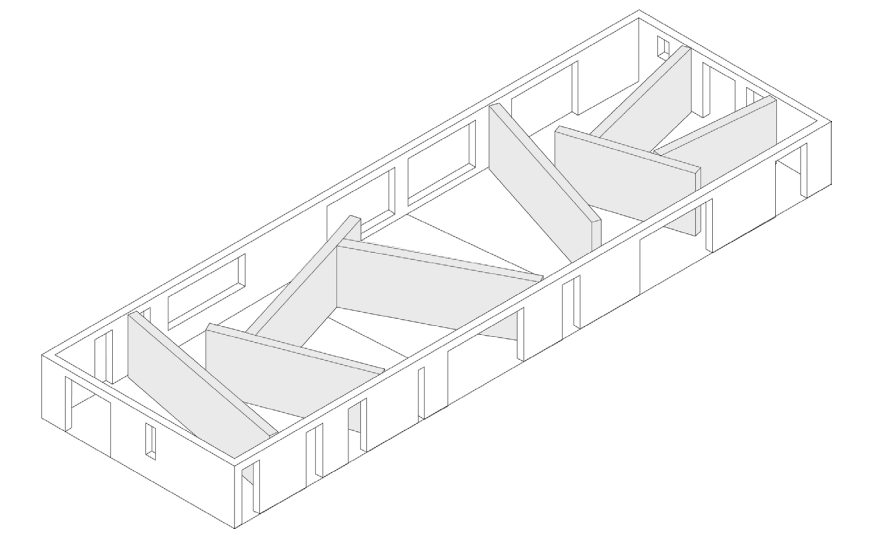

3D

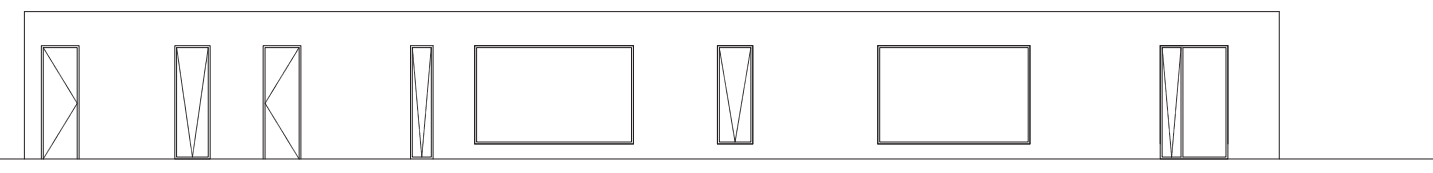

Gevel noord

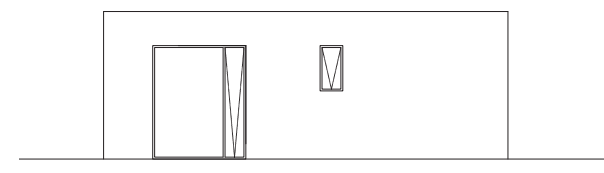

Gevel oost

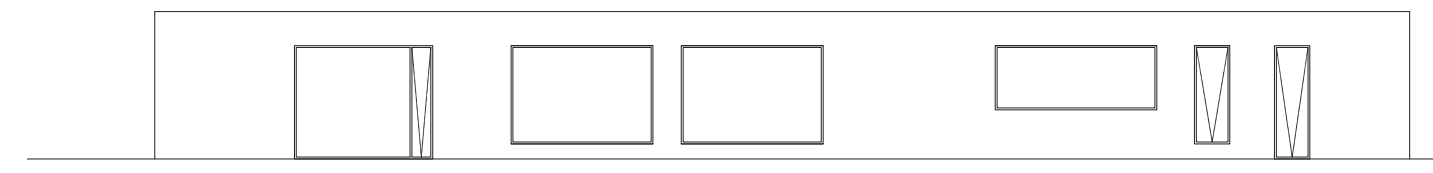

Gevel west

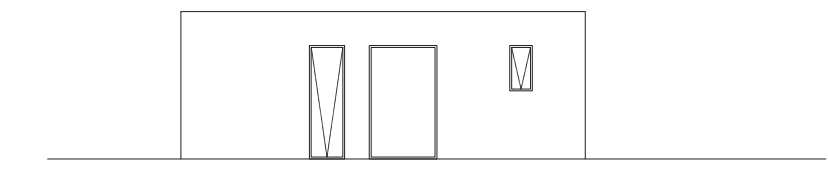

Gevel zuid

5 | HUIS ZONDER OPENINGEN  
1:200

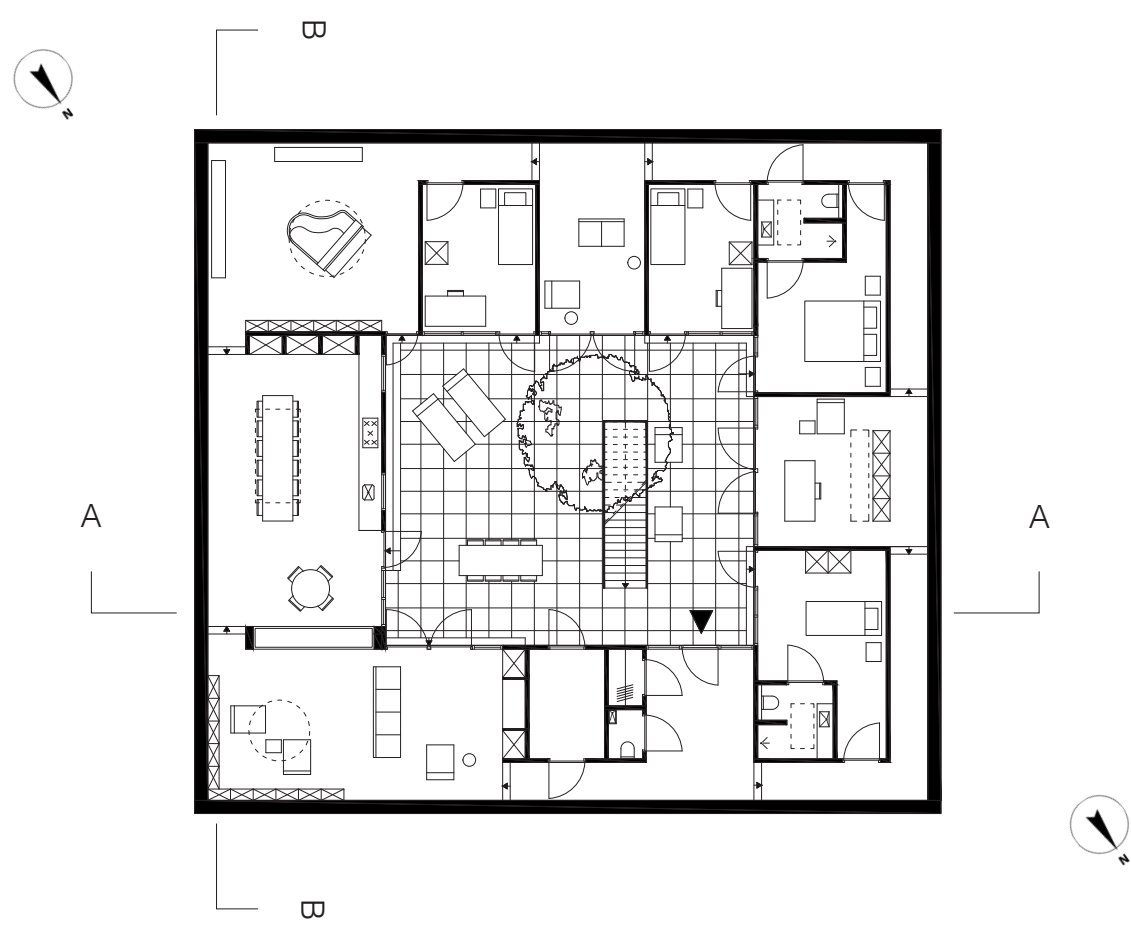

Begane grond

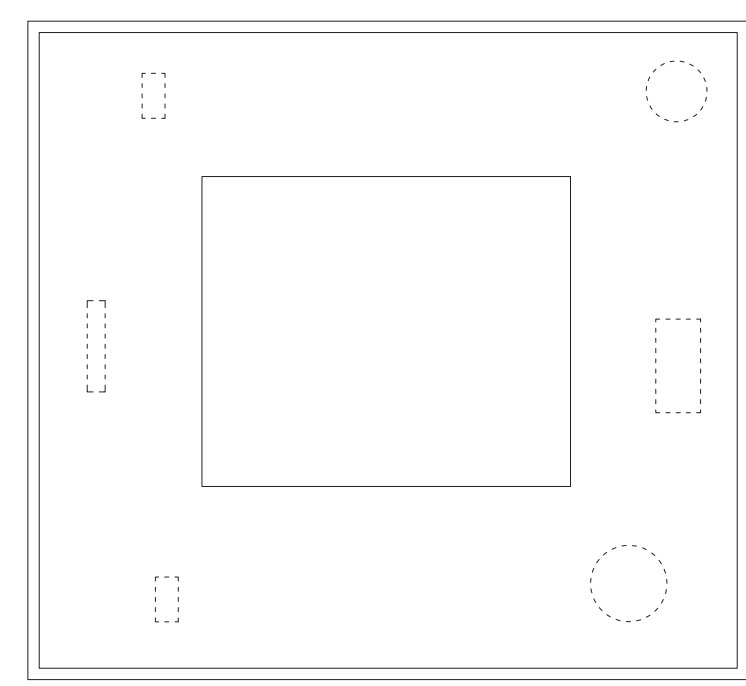

Dakaanzicht

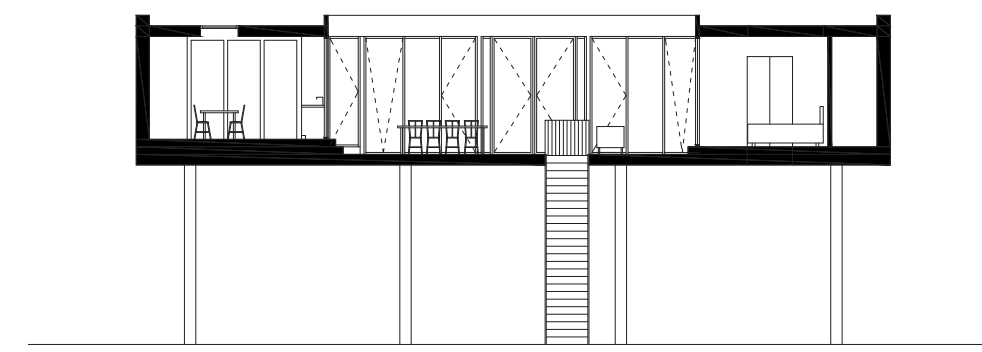

Doorsnede A

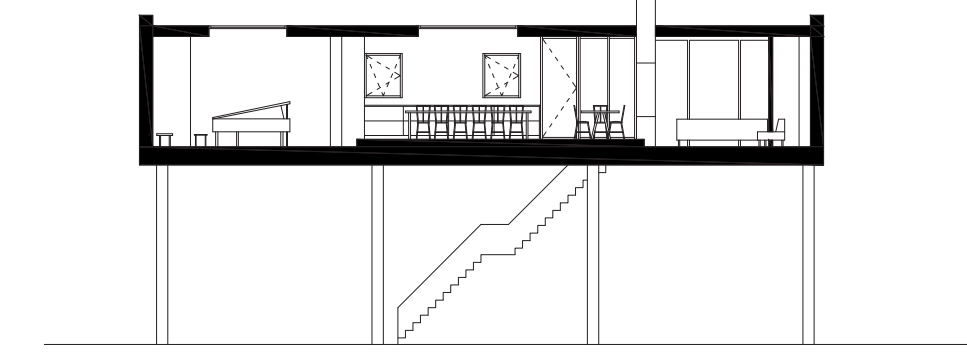

Doorsnede B

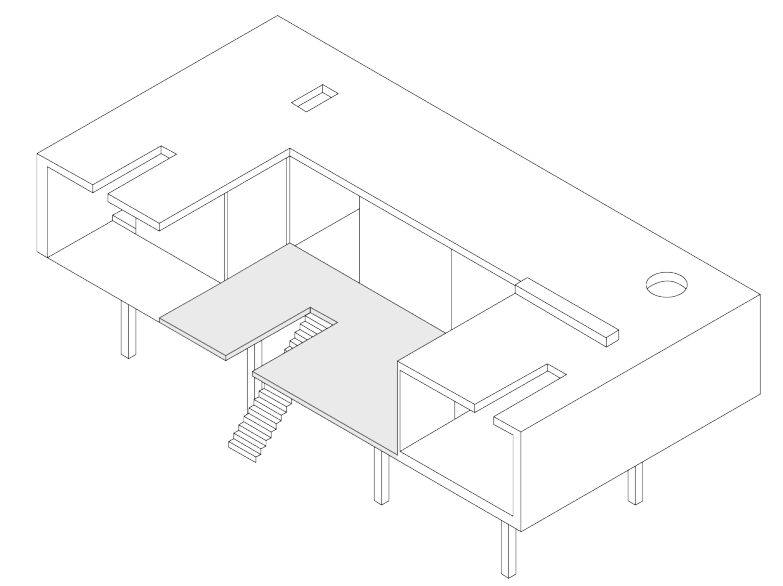

3D

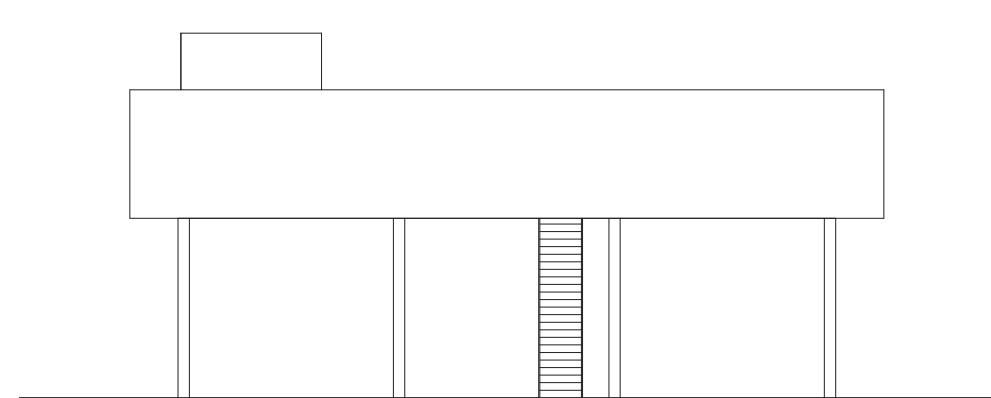

Gevel noord

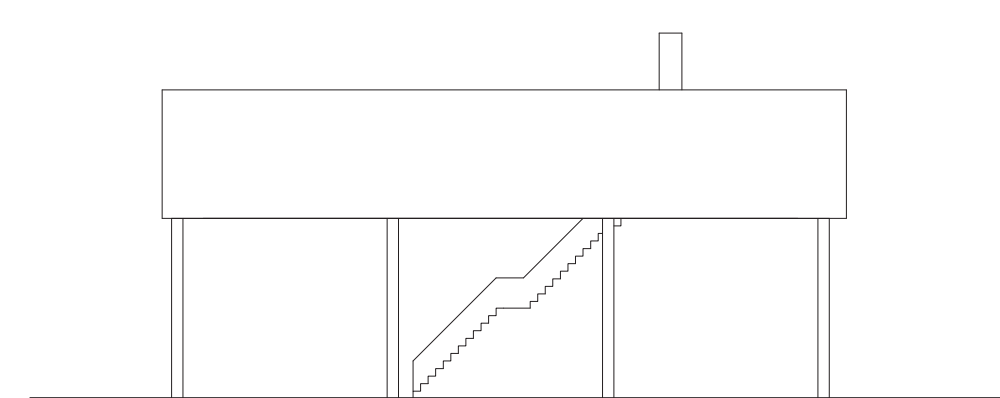

Gevel oost

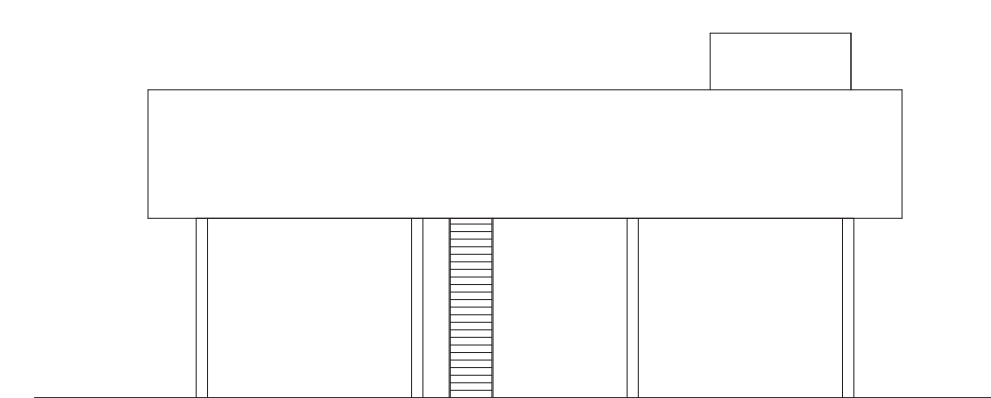

Gevel zuid

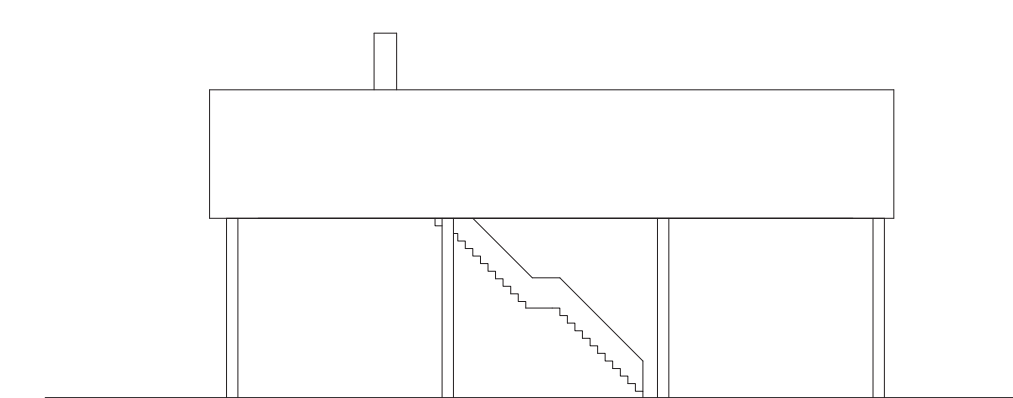

Gevel west

6 | DRIELUIK: 'HET ALWETENDE BOEKENHUIS'